



Tilt Tables

FROM CHINESPORT'S GENERAL CATALOGUE – 2015 EDITION



Chinesport thanks all collaborators who have given their contribution to achieve the present document.



The equipment illustrated in the present chapter can be subject of specific training and multilevel courses arranged by qualified professionals. So upon request it's possible to arrange events at Chinesport's head office or other site indicated by the customer.

Therapy tables	1
Electro-medical Equipment	2
Rehabilitation	3
Pulley therapy	4
Occupational therapy	5
Standing frames	6
Tilt Tables	7
Parallel Bars and Exercise Staircases	8
Walkers	9
Treadmills	10
Tractions	11
Medical Gym	12
Hydrotherapy	13
Postural Analysis	14
Hoisting and Transfer	15
Hygiene and Anti - Decubitus	16
Relax Armchairs	17
Wheelchairs and Healthcare Beds	18

At our sole discretion, the company reserves the right to change dimensions and type of construction, and to make improvements and other changes to its products. All reproduction rights of all or part of the designs and illustrations are reserved worldwide. The printing process can't give a perfect reproduction of the colours.



Tilt Tables

FROM CHINESPORT'S GENERAL CATALOGUE – 2015 EDITION

-
- 04 Introduction**

 - 05 Choice of the upholstery colour**

 - 06 Straps, supports and upholstery items**

 - 08 Electrical accessories**

 - 09 Specific accessories**

 - 10 Tilt tables for supine position**

 - 13 Tilt tables for supine position and treatments**

 - 14 Tilt tables for prone and supine position**

 - 16 Bobath table with tilt function**

 - 18 Postural cushions**

Within a motor, strength and balance re-education programme, these tilt tables help to gradually reach an erect posture from a static prone or supine position when patients are unable to load their own body weight on their lower limbs. Chinesport's static tables in a supine or prone position are recommended for use for both adults and children. They have a three year guarantee.

PRODUCT CODE MEANING

The product code for Chinesport static tables depends on the configuration of the various options available. Each position in the code has a specific meaning, and corresponds to one or more characteristics of the product. Soon we propose introducing what is termed an "open code" with a number of options to be chosen freely, as already offered for our examination and therapy couches, or our shower stretchers.

Specifically, a model with gas spring servo-assisted tilt adjustment can be chosen, or an electrical system powered by mains power or a rechargeable battery. Electrical height adjustment is also provided for some models of the table, if you also want alternative use for physical therapy sessions.

The drives offered for tipping the table upright, provide for working safely with various loads, up to 140 kg or 180 kg. Some icons are shown for each model presented, for easier identification of the properties described.



TILT TABLES



The FIRST PART of the code is predefined, and identifies the principal characteristics.

The SECOND PART of the code relates to the colour choice for the upholstery.

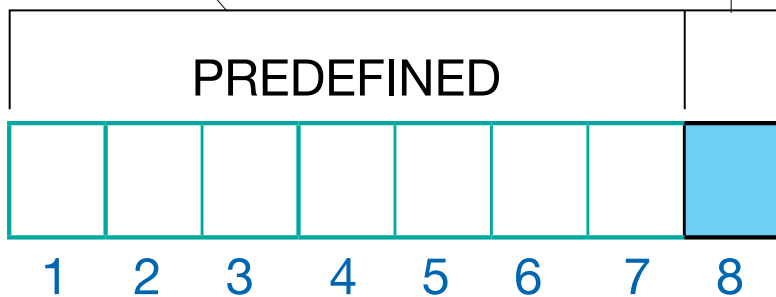

POSITION	VARIABLE CODE MEANING	VALUES AVAILABLE
1-2		SET VALUES
3	TYPE OF ADJUSTMENT	1 - no height adjustment 2 - electrical height adjustment 3 - gas spring tilt adjustment
4	TYPE OF POWER SUPPLY	E - mains power supply B - rechargeable battery power supply G - no electrical supply
5	SAFETY WORKING LOAD	1 - up to 140 kg 2 - up to 180 kg
6	NUMBER OF SECTIONS	1 - 3 sections, without head section for static supine position 2 - 4 sections, with head section for static supine position 3 - 1 section, for static supine position 4 - 4 sections, for static supine position
7	TYPE OF IMITATION LEATHER	W - GIOTTO collection, rounded edges X - GIOTTO collection, edges with band
8	COLOUR	24 colours available

POSITION 7

W TYPE OF IMITATION LEATHER



COMFORT AND ELASTICITY



EASY TO MAINTAIN



CUT RESISTANT



UV RAY RESISTANT



IMPERMEABLE



FUNGICIDAL TREATMENT

Giotto Collection Standard Line

Giotto is a flameproof, coated fabric. Its strong structure and easy maintenance make it particularly suitable for use in hospitals, clinics, spas, rehabilitation centres and gyms. Giotto has a skin-effect surface and glossy finish, in a wide range of colours. Giotto contains Vinyzene, an antimicrobial that is added during the machining phase, to create a defensive barrier against mites, bacteria and fungi, avoiding unpleasant odours and allergies.

POSITION 8

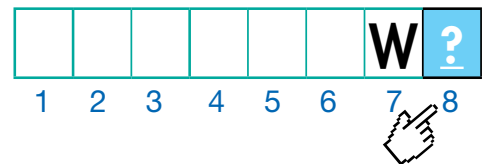

? Colour of upholstery for the sections.

When ordering remember to state the colour code for the upholstery. Available on a standard range of 24 colours.

A WHITE	New N IVORY	8 BEIGE	7 ASH GRAY	New K GRAY	S DARK BROWN
B CREAM	4 YELLOW	T GREEN LEMON	1 DARK GREEN	6 LIGHT GREEN	New E AQUAMARINE
Z ORANGE	New G CORAL	F RED	H BURGUNDY	9 FUCHSIA	New Q LILAC
R LIGHT CORNFLOWER BLUE	2 LIGHT BLUE	3 MARINE BLUE	L DARK BLUE	M ANTHRACITE	P BLACK

XCAT0020131

FOLDER OF UPHOLSTERY COLOURS

For designers as well as for the single professional, who would like to verify the real colour of the imitation leather before taking a purchase decision, we can send a samples folder for free.



STABILITY OF THE PANELS

always guaranteed by a fixing system with bushings in the frame.



FIRE-RESISTANT
UNI 9175 class 1 IM
EN 1021-2 BS 5852-1

STRAPS, SUPPORTS AND UPHOLSTERED ITEMS

Chinesport's static tables are designed as "open products", that is, the professional is able to choose the accessories they require to complete the unit. A series of important accessories are presented here that are used to complete the static table's configuration, and provide the best answer to the specific needs of operators and users.



The model shown is code LT1E14W6 - TILT TABLE E PRO with accessory AC0310 for static supine use.



AC0005 - BASIC STRAP

Provides better restraint for the patient; can be fitted at the desired height by means of special guides. (single piece)



AC0006 - STRAP PADDING

Padded cushion offering greater and more comfortable support to the patient. To be used in combination with strap code AC0005. (single piece)



AC0560 - PADDED TRUNK STRAP

A strap with a padded support for comfortable, safe, retention of the person. It is recommended for fitting at the trunk or pelvis. The strap's adjustment and fixing system is easy for the operator to use. It can be used for all static tables, in the supine position. (single piece)



AC0561 - SEPARATE LEG STRAPS

A strap with a padded support for positioning and stabilising an individual lower limb. This type of strap can be used for static tables that have a central guide for anchoring the strap. In particular, it can be used for all static tables, in the supine position. (2 pieces)



AC0088 - PADDED LEG STRAP

A broad strap with a padded support for containing both lower limbs. It has a double fixing on the side and a system that facilitates fitting by the operator. It can be used for all static tables, in the supine position. (single piece)



AC0087.W ? - CERVICAL CUSHION

A padded, shaped cushion for lateral containment and stabilisation of the neck. This cushion has a special strap that can be fitted or removed quickly, depending on the specific situation. (single piece)

? CHOICE OF UPHOLSTERY COLOR - important: always specify the upholstery code along with the chosen item when this option is available.



STRAPS, SUPPORTS AND UPHOLSTERED ITEMS



AC0003 - LATERAL SUPPORTS

Side supports made from soft material, adjustable in height, width and depth. (2 pieces)



AC0517.W ? - PADDED SUPPORTS

Shaped side supports that offer a larger contact surface with the patient. These are supplementary or alternative to article code AC0003 and can be adjusted in height, width, and depth. (2 pieces).



AC0004 - HAND GRIPS

Side handles to allow the patient to grip and support themselves while exercising in a static supine position. They can be adjusted in height and depth. (2 pieces).



AC0090 - FOREARM SUPPORTS

Forearm supports with hand grips for a comfortable hold. They can be adjusted in height and rotated, while the hand grips also have a depth adjustment. (2 pieces).



AC0002 - INTRA-EXTRA SANDALS

Once fitted to the footplates, they restrain and stabilise the feet. Can be adjusted into intra-extra rotation and anteroposterior rotation. (2 pieces)



AC0020.W ? - BREATHING HOLE PLUG

Chinesport's static tables come with a standard breathing hole and plug. It can be ordered as an accessory in the same colour as the table.



+/-20°

SEPARATE FOOTREST FLEXO-EXTENSION

AC0096 WEDGE FOR CLUB FEET

The foot rests can be adapted to provide a greater incline of the footrest that can go to -30° for extension and +10° for flexion, where required for patients with a club foot. The specific accessory must therefore be ordered.

+10°/-30°

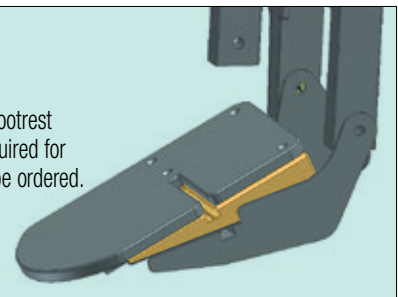

The model shown is code *LT1E14W6*
- TILT TABLE E PRO with
accessory *AC0309* Service table.

ELECTRICAL ACCESSORIES

Should the standard battery provided be damaged or wear down, an additional battery can be ordered using the accessory code shown below. It is very important to respect the battery recharging procedure in order to extend its working life. All static tables that are battery powered, come with a battery charger as standard equipment. However, a spare or replacement battery charger can be ordered. Also, all models with electrical tilt adjustment, come with a standard handset with magnets. However, you can also include an additional handset or foot switch, with a support in the frame.

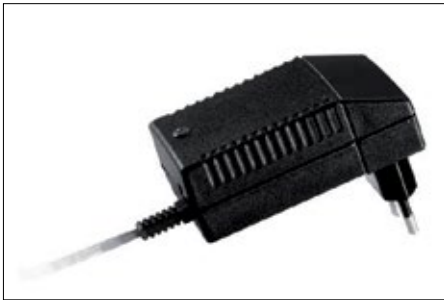

AC0319 - BATTERY CHARGER

This can be used to recharge the battery supplied or spare batteries, by connecting it to the electricity mains. The power supplies that can be used are 110/220V - 50/60 Hz - 500 mA. It comes with a standard Italian plug, compatible with SHUKO socket. By request, it can be supplied with other type of plug.

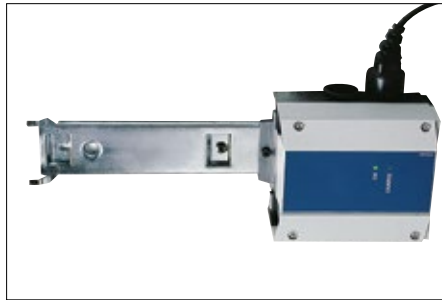

AC0318 - WALL-MOUNTED BATTERY CHARGER

This can be used to recharge the battery supplied or spare batteries, by connecting it to the electricity mains. The power supplies that can be used are 110/220V - 50/60 Hz - 500 mA. It comes with a standard SHUKO plug. By request a cable can be provided with another plug.



01132 - SPARE BATTERY

Allows continuous use, while the other battery is charging. The internal power supply is 24 V / max 10 AT.



AC0039 - ADDITIONAL HANDSET

Ergonomic, new generation handset with magnets - can be attached to the frame of the table as the operator wishes. It comes with power cord.

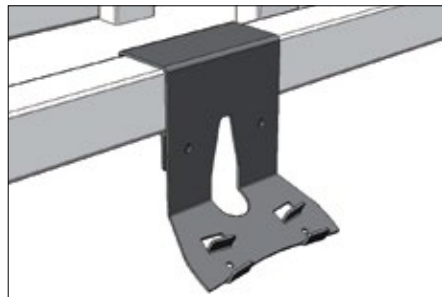

AC0575 - PEDAL SUPPORT

Can be fitted on either side of the bed, as the operator wishes, and is used to house accessory AC0083.



AC0083 - ADDITIONAL CONTROL

Can be used as a foot switch, along with the relevant support, code AC0575, or as a hand-held control. It is fitted with magnets to make it easy to attach to the frame wherever you wish.



AC0578 - SAFETY DEVICE

This device disables all available electrical functions when the carer is away.



TILT INDICATOR

All Chinesport's static tables have a protractor that is a standard fitting, to indicate the tilt in degrees. During the rehabilitation programme, it is therefore possible to monitor the progression in reaching and maintaining an upright position.

SPECIFIC ACCESSORIES



AC0081 SUPINE STATIC TABLE

This work table can be used with one-, three- or four-section tables when the patient is in a static supine position. The table is contoured so forearms can be easily rested on it. Can be adjusted in height, depth and tilt. Dimensions: 700 x 560 mm



AC0309 - PRONE STATIC TABLE

This work table can only be used with PRONO tilt tables, ref. models LT1B14 and LT1E14. Can be adjusted in height, depth and tilt. Dimensions: 700 x 560 mm



AC0308 - BOBATH TILT TABLE

This work table can only be used with BOBATH tilt table, ref. model LB492F2. The table is contoured to provide comfortable support to forearms. Can be adjusted in height, depth and tilt. Dimensions: 700 x 560 mm



AC0310.W ? - SUPINE STATIC HEAD SECTION

This part can be used as an alternative when the tilt table is in supine position. The accessory is only suitable for models LT1B14 and LT1E14. It is provided with guides to allow for restraining straps to be fitted. Dimensions: 680 x 600 mm



AC0311 - ABDUCTION BLOCK

Helps keep lower limbs separated when the patient is in a static position. It can be fitted whenever required and is height adjustable. Only for models LT1E14, LT1B14, LB492F2.



AC0312 - GUIDE FOR BASE STRAP

Helps to safely fit the lower limbs restraining straps. If required, a separate fitting device can be used. Only for models LT1E14, LT1B14, LB492F2.

? CHOICE OF UPHOLSTERY COLOR - important: always specify the upholstery code along with the chosen item when this option is available.



TiltTables for supine position



LT3G33W? TILT TABLE G



Single-section tilt table for static exercises in supine position for up to 120 kg. Up to 90° tilt via two-gas spring servo-assisted system. Lifting takes place in a continuous movement and with minimal effort for the carer, while the user is on board. It is fitted with tilt angle indicator; height from ground is 85 cm.

The table does not come with any containment band, which must be chosen from among the accessories available. It can be moved with a mobile lift or medical equipment trolley, clearance under the table base is 17 cm. Transport is made easier by the wide diameter, braked casters, one of them being directional.

The footplate is ready to fit the sandals AC0002.



Clearance under the table allows access by patient lifts or medical equipment trolleys

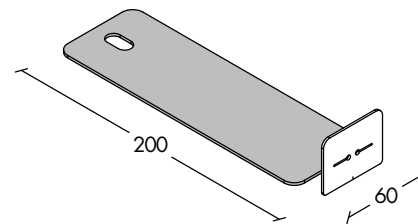

TILT TABLES



TECHNICAL SPECIFICATIONS

ARTICLE CODE	LT3G33 Tilt table G
Number of sections	1
Maximum safe working load (kg)	120
Tilt adjustment	with gas spring
Power supply	not applicable
Tilt indicator in degrees	standard
Table height from the floor (cm)	85
Maximum user height (cm)	200
Caster diameter (mm)	125
Individual brake system	on each single wheel
Steering wheel	standard
Padding upholstery safety class	1 IM
Padding thickness (mm) / density (kg/m ³)	30 / 30
Weight (kg)	60

ACCESSORIES

- AC0005 BASIC STRAP
- AC0006 STRAP PADDING
- AC0560 PADDED TRUNK STRAP
- AC0088 PADDED LEG STRAP
- AC0087.W ? CERVICAL CUSHION
- AC0003 LATERAL SUPPORTS
- AC0517.W ? PADDED SUPPORTS
- AC0004 HAND GRIPS
- AC0090 FOREARM SUPPORTS
- AC0002 INTRA-EXTRA SANDALS
- AC0020.W ? BREATHING HOLE PLUG
- AC0081 SUPINE STATIC TABLE

? CHOICE OF UPHOLSTERY COLOR - important: always specify the upholstery code along with the chosen item when this option is available.





LT1E11W? TILT TABLE E



Three-section tilt table for static exercises in supine position for up to 140 kg. Up to 90° tilt with wall power supply, 24V low voltage, and operated by hand control. It is fitted with tilt angle indicator; height from ground is 56 cm. The table does not come with any containment band, which must be chosen from among the accessories available. A central guide between the two lower limbs support sections allows for the restraining strap to be better fitted and secured. Transport is made easier by the wide diameter, braked casters, one of them being directional. Footplates can be independently adjusted by +/- 20°.

LT1B11W? TILT TABLE B



Version with 24 V rechargeable battery supply. Battery charger included.

LT1E21W? TILT TABLE E PLUS



Version with wall power supply for up to 180 kg. An additional manual lowering system is provided, in case a black-out occurs.

LT1B21W? TILT TABLE B PLUS



Version with 24 V rechargeable battery supply for up to 180 kg. Battery charger included.

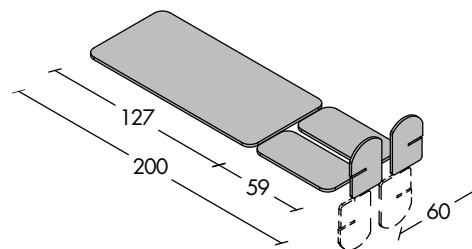

ACCESSORIES

- AC0005 BASIC STRAP
- AC0006 BAND PADDING
- AC0560 PADDED TRUNK BAND
- AC0561 SEPARATE LEG BANDS
- AC0088 PADDED LEG BAND
- AC0087.W ? CERVICAL CUSHION
- AC0003 LATERAL SUPPORTS
- AC0517.W ? PADDED SUPPORTS
- AC0004 HAND GRIPS
- AC0090 FOREARM SUPPORTS
- AC0002 INTRA-EXTRA SANDALS
- AC0096 WEDGE FOR CLUB FEET
- AC0319 BATTERY CHARGER
- AC0318 WALL-MOUNTED CHARGER
- 01132 SPARE BATTERY
- AC0039 ADDITIONAL HANDSET
- AC0575 PEDAL SUPPORT
- AC0083 ADDITIONAL CONTROL
- AC0578 SAFETY DEVICE
- AC0081 SUPINE STATIC TABLE

TECHNICAL SPECIFICATIONS

ARTICLE CODE	LT1E11	LT1B11	LT1E21	LT1B21
	Tilt table E	Tilt table B	Tilt table E Plus	Tilt table B Plus
Number of sections	3	3	3	3
Maximum safe working load (kg)	140	140	180	180
Tilt adjustment	electrical	electrical	electrical	electrical
Power supply	mains	battery	mains	battery
Tilt indicator in degrees	standard	standard	standard	standard
Table height from the floor (cm)	56	56	56	56
Maximum user height (cm)	200	200	200	200
Caster diameter (mm)	125	125	125	125
Individual brake system	on each single wheel	on each single wheel	on each single wheel	on each single wheel
Steering wheel	standard	standard	standard	standard
Padding upholstery safety class	1 IM	1 IM	1 IM	1 IM
Padding thickness (mm) / density (kg/m3)	30 / 30	30 / 30	30 / 30	30 / 30
Weight (kg)	65	65	65	65

For models that use mains power: 220 V 50 / 60 Hz / 24 V 70 VA; For models that use battery power: 24 V / max 10AT; Battery charger: 110 / 220 V - 50 / 60 Hz - 500 mA.

? CHOICE OF UPHOLSTERY COLOR - important: always specify the upholstery code along with the chosen item when this option is available.



TiltTables for supine position



LT1E12W? TILT TABLE ET



Four-section tilt table for static exercises in supine position for up to 140 kg. Up to 90° tilt with wall power supply, 24V low voltage, and operated by hand control. It is fitted with tilt angle indicator; height from ground is 56 cm. Head end section can be adjusted up/down by gas spring. The table does not come with any containment band, which must be chosen from among the accessories available. A central guide between the two lower limbs support sections allows for the restraining strap to be better fitted and secured. Transport is made easier by the wide diameter, braked casters, one of them being directional. Footplates can be independently adjusted by +/- 20°.

LT1B12W? TILT TABLE BT



Version with 24 V rechargeable battery supply. Battery charger included.

LT1E22W? TILT TABLE ET PLUS



Version with wall power supply for up to 180 kg. An additional manual lowering system is provided, in case a black-out occurs.

LT1B22W? TILT TABLE BT PLUS



Version with 24 V rechargeable battery supply for up to 180 kg. Battery charger included.



ACCESSORIES

- AC0005 BASIC STRAP
- AC0006 BAND PADDING
- AC0560 PADDED TRUNK BAND
- AC0561 SEPARATE LEG BANDS
- AC0088 PADDED LEG BAND
- AC0087.W ? CERVICAL CUSHION
- AC0003 SUPPORTS
- AC0517.W ? PADDED SUPPORTS
- AC0004 HAND GRIPS
- AC0090 FOREARM SUPPORTS
- AC0002 INTRA-EXTRA SANDALS
- AC0096 WEDGE FOR CLUB FEET
- AC0020.W ? BREATHING HOLE PLUG
- AC0319 BATTERY CHARGER
- AC0318 WALL-MOUNTED CHARGER
- 01132 SPARE BATTERY
- AC0039 ADDITIONAL HANDSET
- AC0575 PEDAL SUPPORT
- AC0083 ADDITIONAL CONTROL
- AC0578 SAFETY DEVICE
- AC0081 SUPINE STATIC TABLE

TECHNICAL DATA

ARTICLE CODE	LT1E12	LT1B12	LT1E22	LT1B22
	Tilt table E	Tilt table B	Tilt table E Plus	Tilt table B Plus
Number of sections	4	4	4	4
Maximum safe working load (kg)	140	140	180	180
Tilt adjustment	electrical	electrical	electrical	electrical
Power supply	Mains	Battery	Mains	Battery
Tilt indicator in degrees	standard	standard	standard	standard
Table height from the floor (cm)	56	56	56	56
Maximum user height (cm)	200	200	200	200
Caster diameter (mm)	125	125	125	125
Individual brake system	on each single wheel	on each single wheel	on each single wheel	on each single wheel
Steering wheel	standard	standard	standard	standard
Padding upholstery safety class	1 IM	1 IM	1 IM	1 IM
Padding thickness (mm) / density (kg/m3)	30 / 30	30 / 30	30 / 30	30 / 30
Weight (Kg)	65	65	65	65

For models that use mains power: 220 V 50 / 60 Hz / 24 V 70 VA ; For models that use battery power: 24 V / max 10AT

Battery charger: 110 / 220 V - 50 / 60 Hz - 500 mA.

? CHOICE OF UPHOLSTERY COLOR - important: always specify the upholstery code along with the chosen item when this option is available.





LT2E12W? TILT TABLE 2E T



Four-section tilt table for supine position static exercises, examination and physical therapy for up to 140 kg. Can be adjusted in height and tilt up to 90°, with wall power supply, 24V low voltage, and operated by hand control. It is fitted with tilt angle indicator; height from ground is 56 cm. Head end section can be adjusted up/down by gas spring. The table does not come with any containment band, which must be chosen from among the accessories available. A central guide between the two lower limbs support sections allows for the restraining strap to be better fitted and secured. Transport is made easier by the wide diameter, braked casters, one of them being directional. Footplates can be independently adjusted by +/- 20°.

LT2B12W? TILT TABLE 2B T



Version with 24 V rechargeable battery supply. Battery charger included.

Note: A specific device is fitted to allow for an alternative way of adjusting the height or tilt.



ACCESSORIES

- AC0005 BASIC STRAP
- AC0006 BAND PADDING
- AC0560 PADDED TRUNK BAND
- AC0561 SEPARATE LEG BANDS
- AC0088 PADDED LEG BAND
- AC0087.W? CERVICAL CUSHION
- AC0003 LATERAL SUPPORTS
- AC0517.W? PADDED SUPPORTS
- AC0004 HAND GRIPS
- AC0090 FOREARM SUPPORTS
- AC0002 INTRA-EXTRA SANDALS
- AC0096 WEDGE FOR CLUB FEET
- AC0020.W? BREATHING HOLE PLUG
- AC0319 BATTERY CHARGER
- AC0318 WALL-MOUNTED CHARGER
- 01132 SPARE BATTERY
- AC0039 ADDITIONAL HANDSET
- AC0578 SAFETY DEVICE
- AC0081 SUPINE STATIC TABLE



TECHNICAL DATA		
ARTICLE CODE	LT2E12 Tilt table E	LT2B12 Tilt table B
Number of sections	4	4
Maximum safe working load (kg)	140	140
Tilt adjustment	electrical	electrical
Height adjustment (cm)	56 - 106	56 - 106
Power supply	Mains	Battery
Tilt indicator in degrees	standard	standard
Maximum user height (cm)	200	200
Caster diameter (mm)	125	125
Individual brake system	on each single wheel	on each single wheel
Steering wheel	standard	standard
Padding upholstery safety class	1 IM	1 IM
Padding thickness (mm) / density (kg/m3)	30 / 30	30 / 30
Weight (Kg)	100	100

For models that use mains power: 220 V 50 / 60 Hz / 24 V 70 VA ; For models that use battery power: 24 V / max 10AT
Battery charger: 110 / 220 V - 50 / 60 Hz - 500 mA.

? CHOICE OF UPHOLSTERY COLOR - important: always specify the upholstery code along with the chosen item when this option is available.



TiltTables for prone and supine position



Adjustable trunk support



LT1E14W? TILT TABLE E PRO



Four-section tilt table for static exercises in prone position for up to 140 kg. Up to 90° tilt with wall power supply, 24V low voltage, and operated by hand control. It is fitted with tilt angle indicator; minimum height from ground is 56 cm. The trunk support section is height-adjustable. The table does not come with any containment band, which must be chosen from among the accessories available. A central guide between the two lower limbs support sections allows for the restraining strap to be better fitted and secured by means of accessory AC0312. It is also possible to fit the leg separator accessory AC0311. When fitted with accessory AC0310, the table can also be used for static exercises in supine position. Transport is made easier by the wide diameter, braked casters, one of them being directional. The footplate is height-adjustable.

LT1B14W? TILT TABLE B PRO



Version with 24 V rechargeable battery supply. Battery charger included.

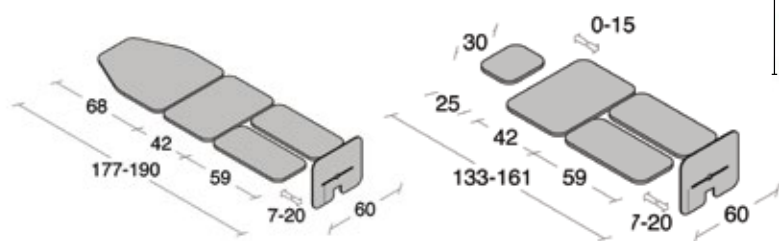

TILT TABLES



TECHNICAL DATA		
ARTICLE CODE	LT1E14	LT1B14
	Tilt table E	Tilt table B
Number of sections	4	4
Maximum safe working load (kg)	140	140
Tilt adjustment	electrical	electrical
Power supply	Mains	Battery
Tilt indicator in degrees	standard	standard
Table height from the floor (cm)	56	56
Maximum user height (cm)	190	190
Caster diameter (mm)	125	125
Individual brake system	on each single wheel	on each single wheel
Steering wheel	standard	standard
Padding upholstery safety class	1 IM	1 IM
Padding thickness (mm) / density (kg/m ³)	30 / 30	30 / 30
Weight (kg)	65	65

For models that use mains power: 220 V 50 / 60 Hz / 24 V 70 VA ; For models that use battery power: 24 V / max 10AT
Battery charger: 110 / 220 V - 50 / 60 Hz - 500 mA.



ACCESSORIES

- AC0005 BASIC STRAP
- AC0006 BAND PADDING
- AC0088 PADDED LEG BAND
- AC0003 LATERAL SUPPORTS
- AC0517.W? PADDED SUPPORTS
- AC0004 HAND GRIPS
- AC0090 FOREARM SUPPORTS
- AC0002 INTRA-EXTRA SANDALS
- AC0319 BATTERY CHARGER
- AC0318 WALL-MOUNTED CHARGER
- 01132 SPARE BATTERY
- AC0039 ADDITIONAL HANDSET
- AC0575 PEDAL SUPPORT
- AC0083 ADDITIONAL CONTROL
- AC0578 SAFETY DEVICE
- AC0309 PRONE-SUPINE STATIC TABLE
- AC0310.W? SUPINE STATIC HEAD SECTION
- AC0311 ABDUCTION BLOCK
- AC0312 GUIDE FOR BASE BAND

? CHOICE OF UPHOLSTERY COLOR - important: always specify the upholstery code along with the chosen item when this option is available.





Fitting the "head end section for use in supine static exercises" - Accessory AC0310

Height-adjustable "Abduction block" - Accessory AC0311

"Abduction block" can be easily slotted into the central arrangement

Lower limbs restraint with "strap guide" - Accessory AC0312

Bobath Table *with tilt function*

L B 4 9 2 F 2 X ? TILT TABLE BOBATH 2ET

Two-section Bobath table for treatment and static exercises in supine position. Height-adjustable up to 250 kg (safe load), or tilt adjustable from 0° to 90° up to 190 kg, with wall power supply, 24V low voltage, and operated by hand control. It is fitted with tilt angle indicator; minimum height from ground is 55 cm. The table does not come with any containment band, which must be chosen from among the accessories available. Head end section can be adjusted up/down by gas spring; it is also provided with breathing hole plug. A central arrangement between the lower limbs support sections also allows for the restraining strap to be better fitted and secured by means of accessory AC0312. Leg separator accessory AC0311 can also be fitted. Table padding with side panel. Casters have a pedal-activated braking system. Footplates can be independently adjusted by +/- 20° and removed when required during physical therapy sessions.

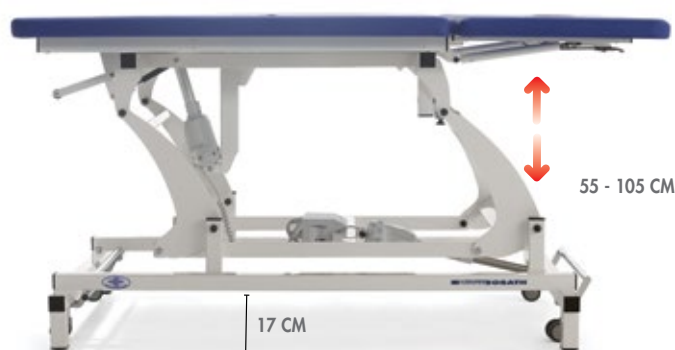
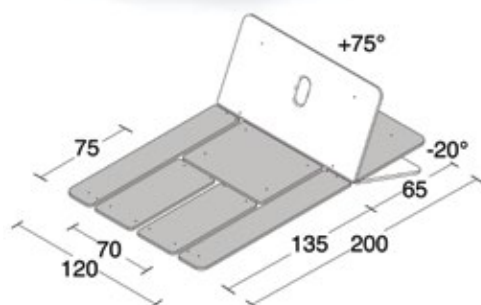

TILT TABLES



TECHNICAL DATA	
ARTICLE CODE	LB492F2X Tilt table Bobath 2ET
Number of sections	6
Maximum safe working load - raised (kg)	250
Maximum safe working load - static (kg)	190
Tilt adjustment	electrical
Height adjustment (cm)	55 - 105
Power supply	Mains
Tilt indicator in degrees	standard
Maximum user height (cm)	200
Caster diameter (mm)	65
Brake system	centralized
Steering wheel	not applicable
Padding upholstery safety class	1 IM
Padding thickness (mm) / density (kg/m3)	40 / 30
Weight (kg)	170

ACCESSORIES

- AC0005 BASIC STRAP
- AC0006 BAND PADDING
- AC0003 LATERAL SUPPORTS
- AC0004 HAND GRIPS
- AC0002 INTRA-EXTRA SANDALS
- AC0096 WEDGE FOR CLUB FEET
- AC0578 SAFETY DEVICE
- AC0308 BOBATH TILT TABLE
- AC0311 ABDUCTION BLOCK
- AC0312 GUIDE FOR BASE BAND

For models that use mains power: 220 V 50 / 60 Hz / 24 V 70 VA ; For models that use battery power: 24 V / max 10AT Battery charger: 110 / 220 V - 50 / 60 Hz - 500 mA.

? CHOICE OF UPHOLSTERY COLOR - important: always specify the upholstery code along with the chosen item when this option is available.



1) Note: A specific safety device is fitted to allow for an alternative way of adjusting the height or tilt.

2) Note: A specific safety device is fitted to allow for the table to be lowered manually in case of power interruption.



Note: This model was designed to help both carer and patient during gym rehabilitation programmes, to avoid the time and possible inconvenience of a transfer from a specific table to another.



Fitting the footplate assembly for use with static exercises in supine position



Removable footplate assembly

SOME ACCESSORY APPLICATION EXAMPLES



Foot restraining sandals accessory AC0002 (2 pieces)

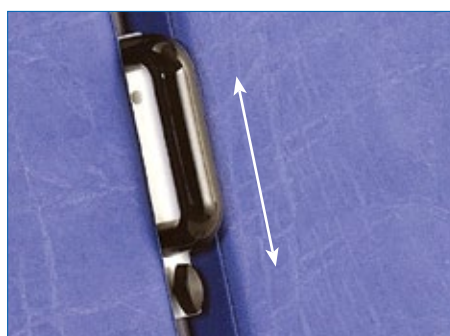

Strap guide accessory AC0312 (single piece)



Abduction block accessory for Leg separation. AC0311 (single piece)

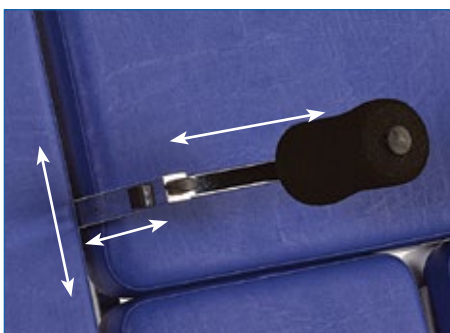

Lateral trunk supports accessory AC0003 (2 pieces)

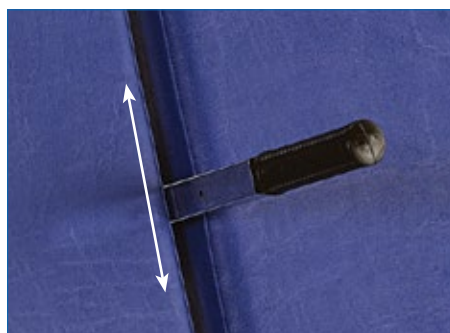

Forearm supports accessory AC0004 (2 pieces)



Work table for static exercises in supine position accessory AC0308 (single piece)

Postural cushions

POSTURAL CUSHIONS

The posture cushions come in various shapes and sizes to suit the several professional needs in positioning the patient correctly. They are made of graduated density and high strength imitation leather that is fireproof, antibacterial, fungicidal and washable. The standard density foam is of 21 kg/m³. The cushions have a removable cover with zip fastening, and there are 24 colour options for the upholstery.

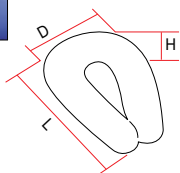

AC0024.W ? FACE PILLOW
L 31 x D 23 x H 6

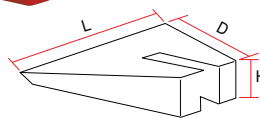

AC0025.W ? FACE DOWN PILLOW
L 40 x D 34 x H 9

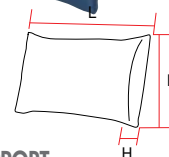

10321.W ? LORDOSIS SUPPORT
L 29 x D 14 x H 5

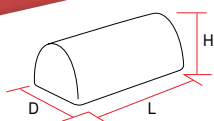

10300.W ? HALF-CYLINDER 1 - L 48 x D 25 x H 18
10310.W ? HALF-CYLINDER 2 - L 60 x D 40 x H 18

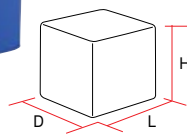

09940.W ? CUBE 1 L 40 x D 40 x H 40
09950.W ? CUBE 2 L 50 x D 50 x H 50

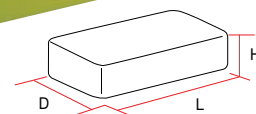
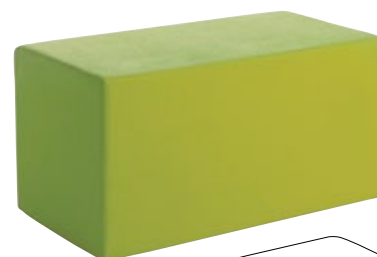

09700.W ? RECTANGLE 1 - L 40 x D 20 x H 10
09730.W ? RECTANGLE 2 - L 40 x D 30 x H 5
09740.W ? RECTANGLE 3 - L 40 x D 30 x H 10
09820.W ? RECTANGLE 4 - L 80 x D 40 x H 40

TILT TABLES



11250.W ? LEG PILLOW
L 77 x D 50 x H 20/15

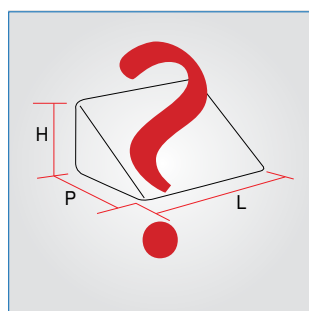
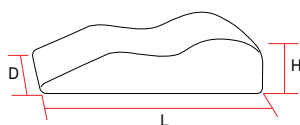

TAILOR-MADE CUSHIONS

We can make cushions with different sizes or density upon request.

Please feel free to send us your request at export@chinesport.it

LEGENDA: L = Length; D = Depth; H = Height; All dimensions are expressed in centimeters (cm).

? CHOICE OF UPHOLSTERY COLOR - important: always specify the upholstery code along with the chosen item when this option is available.

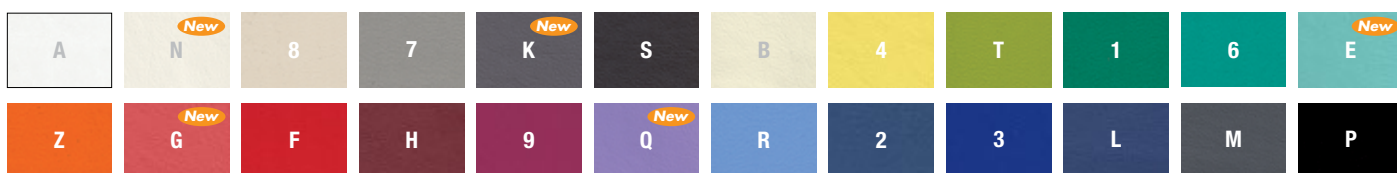



REMOVABLE COVER

The Chinesport mats for gym and cushions are made with high strength synthetic leather, washable, fire-resistant, antibacterial and fungicidal. They have a removable cover.

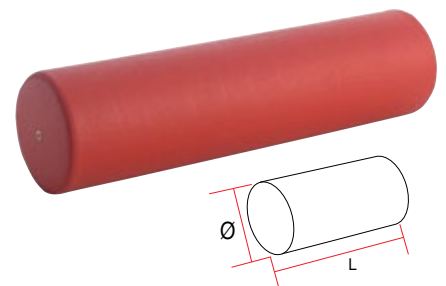
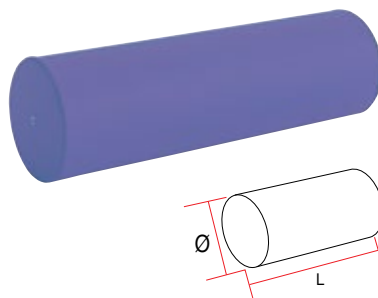
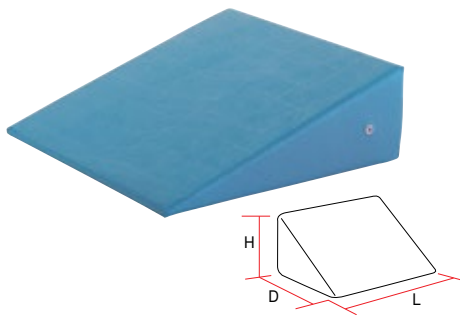

- 09600.W ? WEDGE 1 - L 25 x D 25 x H10
- 09610.W ? WEDGE 2 - L 35 x D 35 x H10
- 09620.W ? WEDGE 3 - L 60 x D 45 x H15
- 09630.W ? WEDGE 4 - L 60 x D 45 x H30
- 09640.W ? WEDGE 5 - L 60 x D 60 x H15
- 09650.W ? WEDGE 6 - L 60 x D 60 x H20

- 10000.W ? CYLINDER 1 - L 20 x Ø 8
- 10010.W ? CYLINDER 2 - L 35 x Ø 15
- 10020.W ? CYLINDER 3 - L 50 x Ø 15
- 10030.W ? CYLINDER 4 - L 50 x Ø 25
- 10050.W ? CYLINDER 5 - L 100 x Ø 25

- 10130.W ? RIGID ROLL 1 - L 100 x Ø 30
- 10150.W ? RIGID ROLL 2 - L 100 x Ø 40
- 10160.W ? RIGID ROLL 3 - L 100 x Ø 50
- 10200.W ? RIGID ROLL 4 - L 50 x Ø 30

Cushions of various sizes, stretchy and moldable and they always return to their original shape; they help to keep the patient in a correct posture, are ideal as lumbar and lateral supports, and as supports for upper and lower limbs. They are covered with a washable breathable fabric.

- 01449 POSTURAL CUSHION 100 - ø cm 19 x 17
- 01450 POSTURAL CUSHION 110 - ø cm 19 x 31
- 01451 POSTURAL CUSHION 120 - ø cm 25 x 37
- 01452 POSTURAL CUSHION 8 - cm 40 x 20 x 13 h
- 01453 POSTURAL CUSHION 88 - cm 50 x 28 x 13 h

01426 SET POSTURAL
The set consists of a carry bag and 5 cushions of different sizes, one for each type as presented above.

Chinesport, just a click away

Chinesport's website has now also been designed and set up for those using mobile phones or iPads, not necessarily because they are out-and-about or travelling, but because they wish to know more about it while using our catalogue or other documentation. We are constantly involved in publishing new detailed information, photos (now even bigger), videos and multimedia files that are worth sharing. Finally, the website also provides a guide to putting the code together for a product made up of a number of parts.



Point, and explore the video!



REHABILITATION and MEDICAL EQUIPMENT

CHINESPORT spa
Via Croazia, 2
33100 Udine - Italy
Tel. 0432 621 621

www.chinesport.com

