



ARCHITECT FILE

HOW TO...

lift a person from A to B

seen from an architectural point of view



This drawing is the property of Ergolet and may not be copied or handed over to a third party without Ergolet written consent

WHO ARE WE?

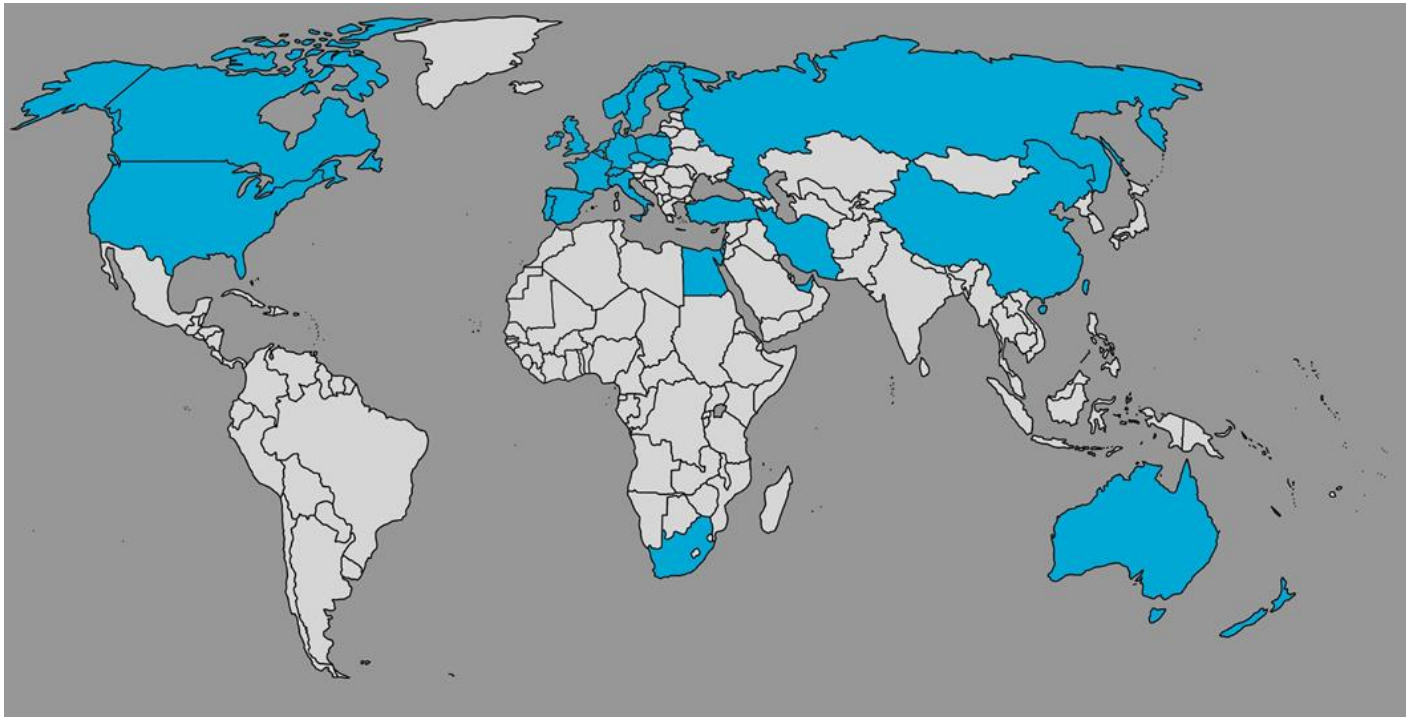

We lift the world

Founded in 1973, Korsoer, Denmark

Changed strategy in 1988:

focus on production of technical aids for the mobility impaired

Products characterised by:

Safety, Comfort, Functionality, Innovative Scandinavian design.

Locations:

Denmark (HQ), United Kingdom (Salesoffice) and Poland (production and salesoffice)

Employees:

160

Distribution:

Sales channels through international distributor network in more than 25 countries.

Main market segments:

Nursing Homes & Hospitals.



www.ergolet.com

This drawing is the property of Ergolet and may not be copied or handed over to a third party without Ergolet written consent

RANGE



SCANDINAVIAN DESIGN & FUNCTIONALITY

Striking a balance between elegant form and excellent function.





www.ergolet.com

This drawing is the property of Ergolet and may not be copied or handed over to a third party without Ergolet written consent

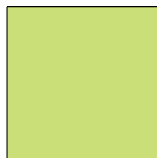
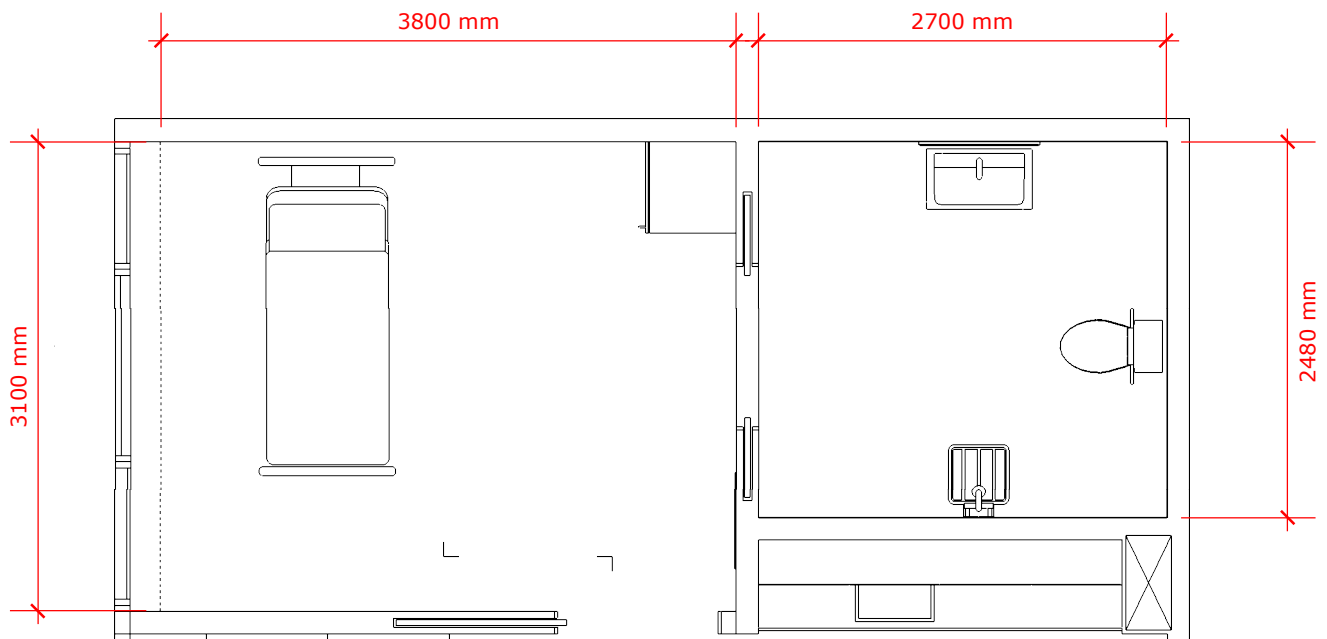
LEGEND

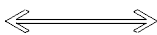

HOW MUCH WILL BE COVERED?
= GREEN AREA



HOW CAN I MOVE THE LIFT?
= FROM A TO B

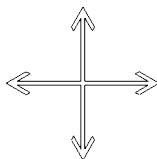

HOW CAN I MOVE THE LIFT?
= ROOM COVERING SYSTEM



HOW CAN I MOVE THE LIFT?
= FROM ROOM TO ROOM (R-T-R)

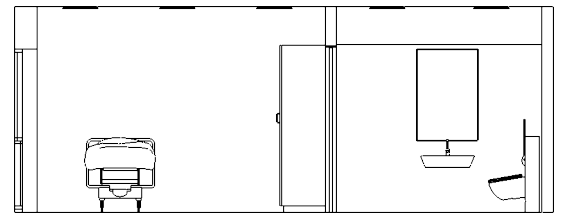

BEDROOM

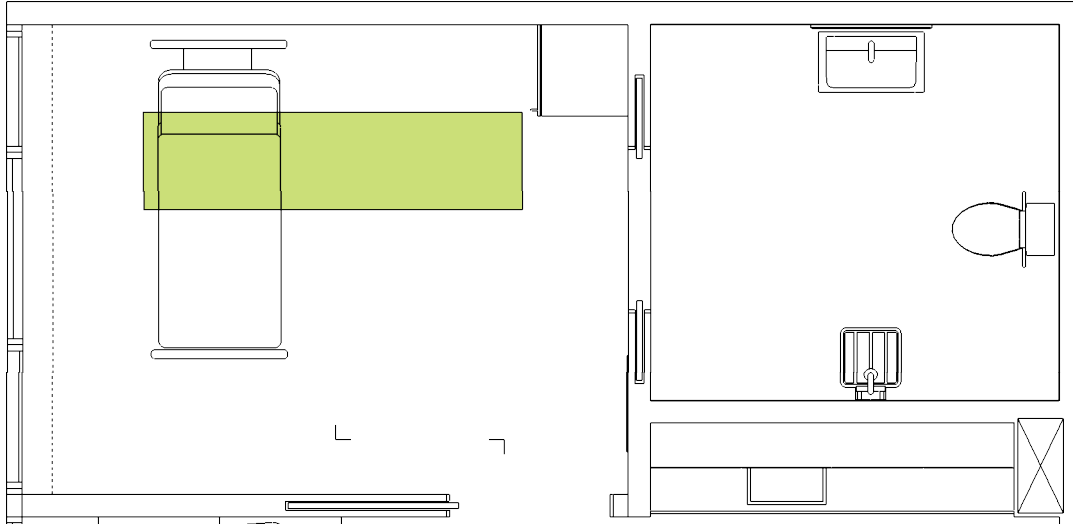

CEILING MOUNTED

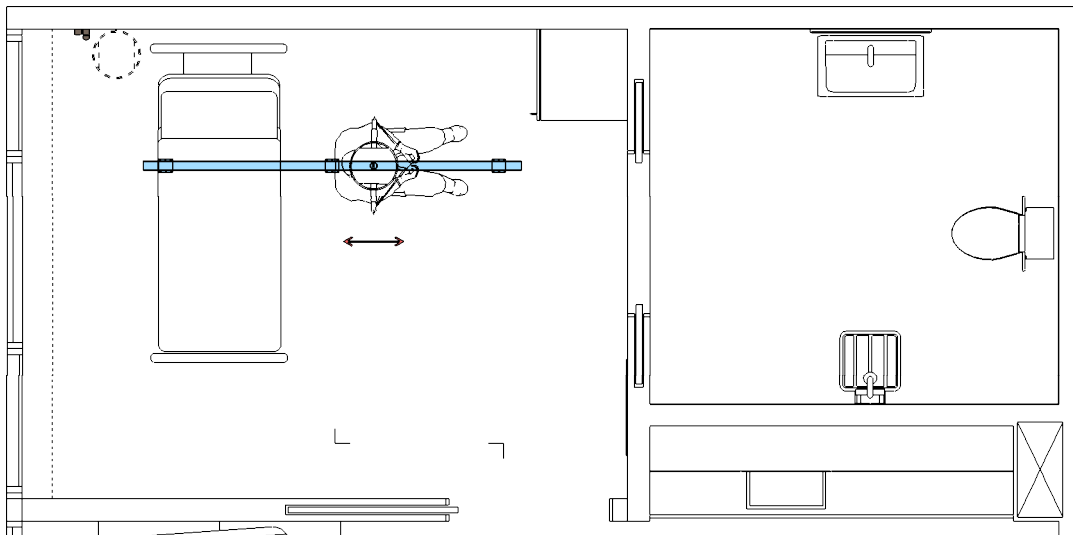

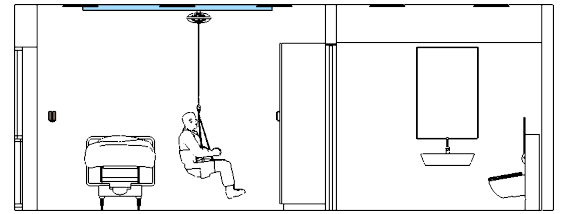

BEDROOM

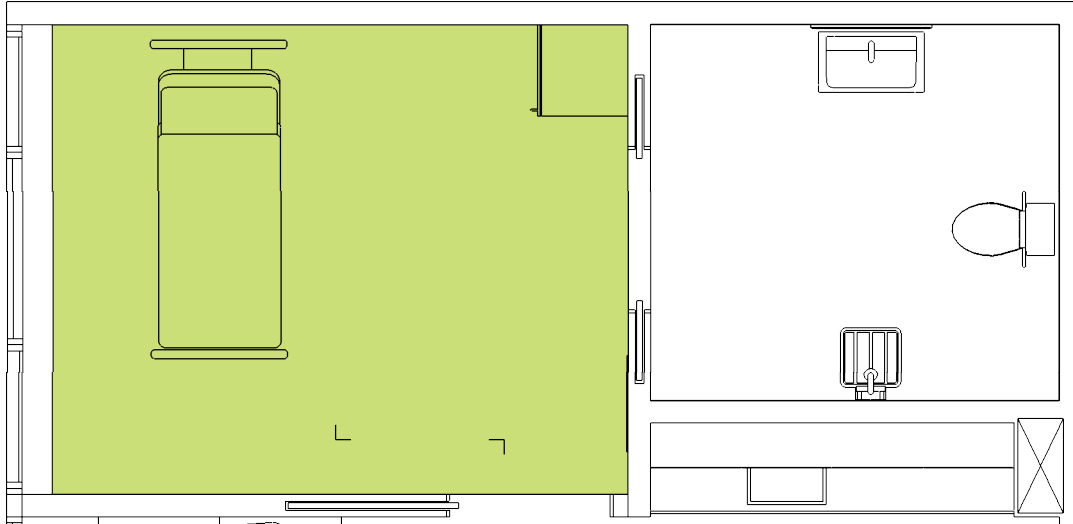

WALL MOUNTED

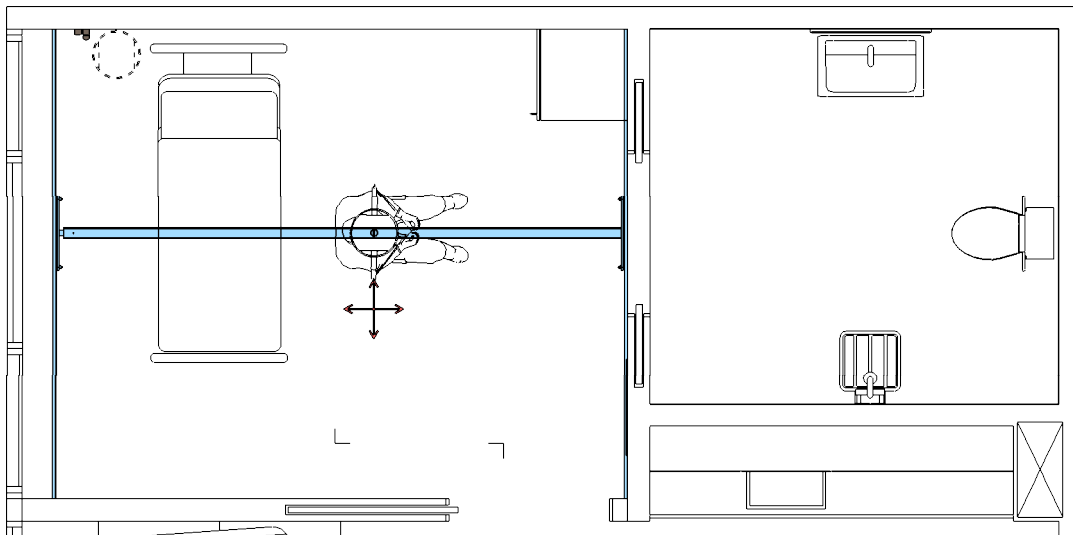

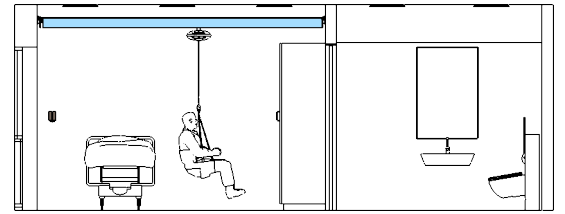

BEDROOM

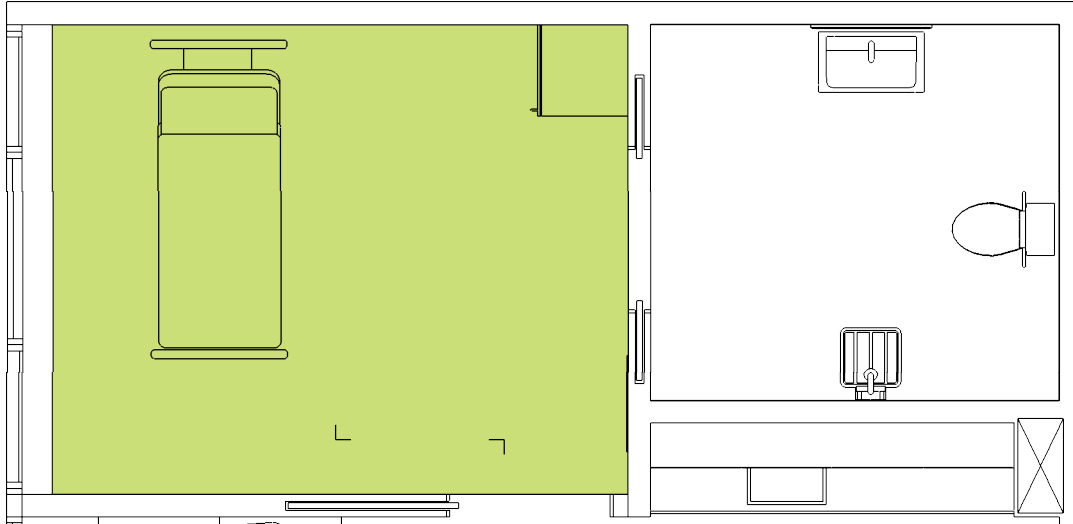

CEILING MOUNTED

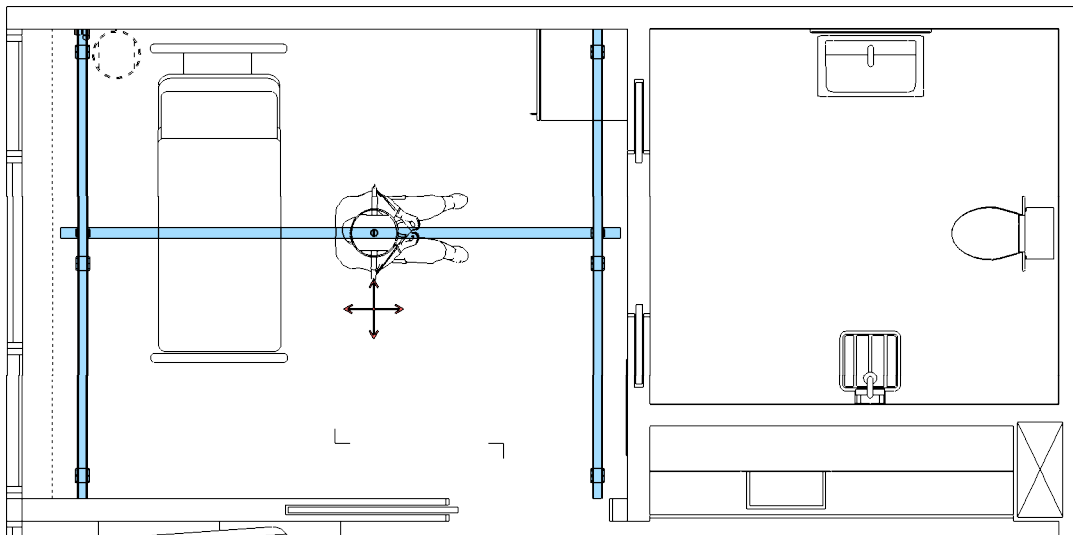

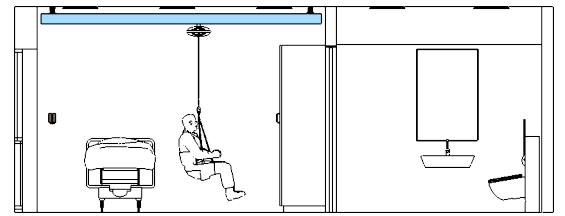

BATHROOM

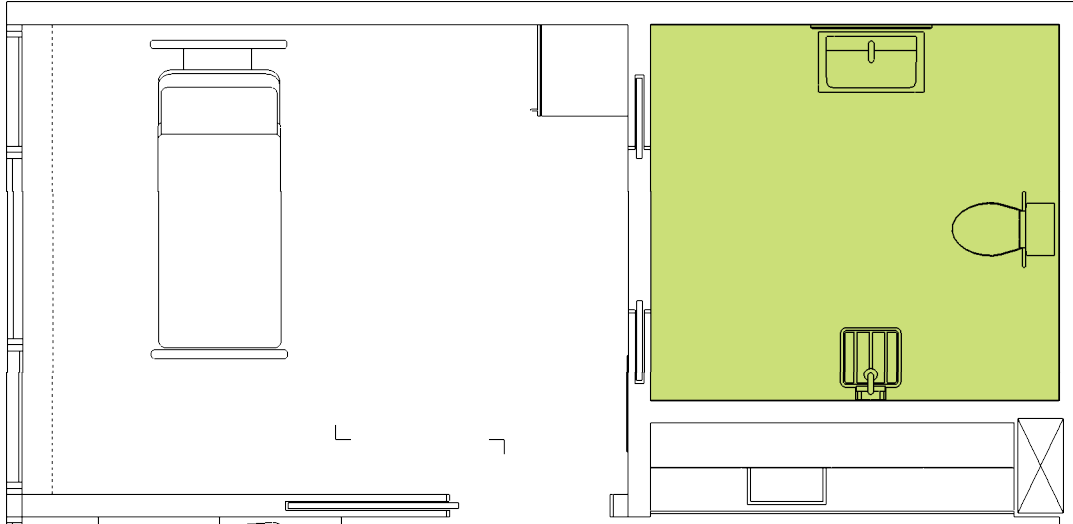

WALL MOUNTED

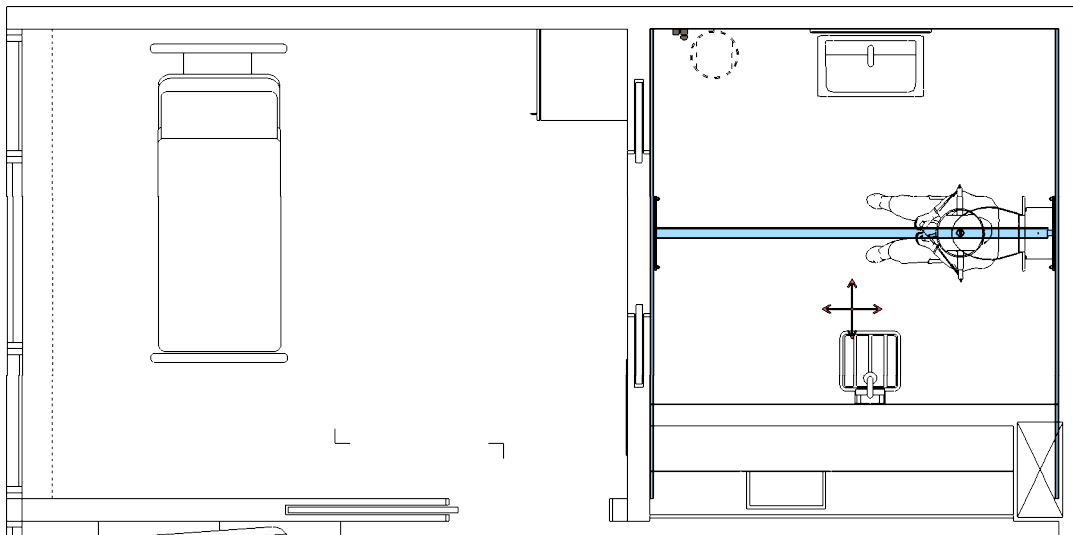

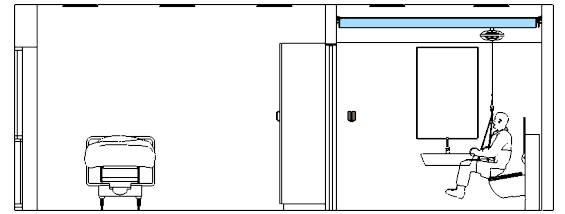

BATHROOM

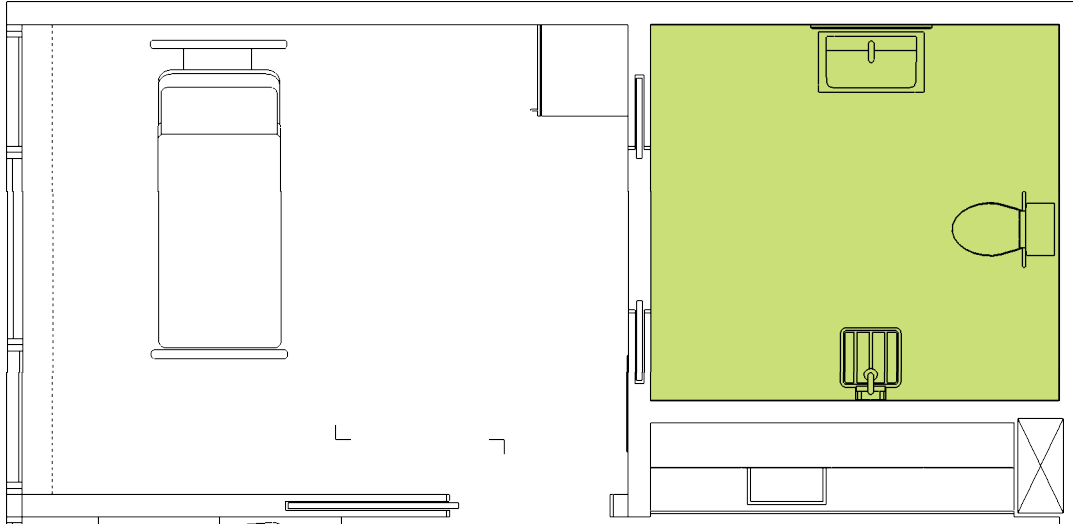

CEILING MOUNTED

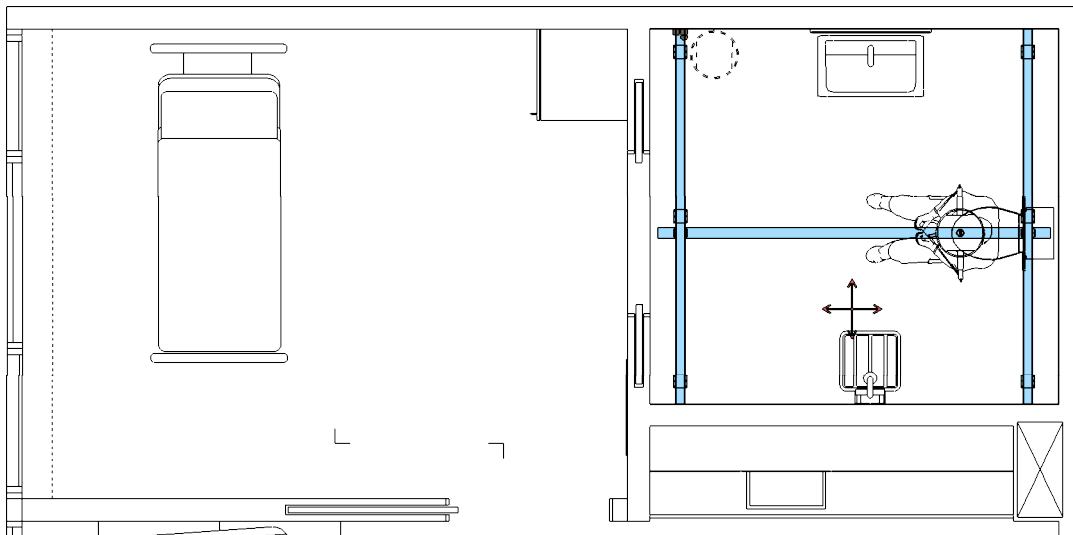

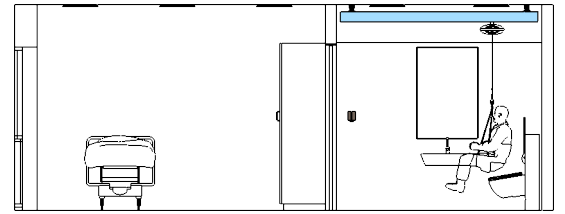

ROOM-TO-ROOM

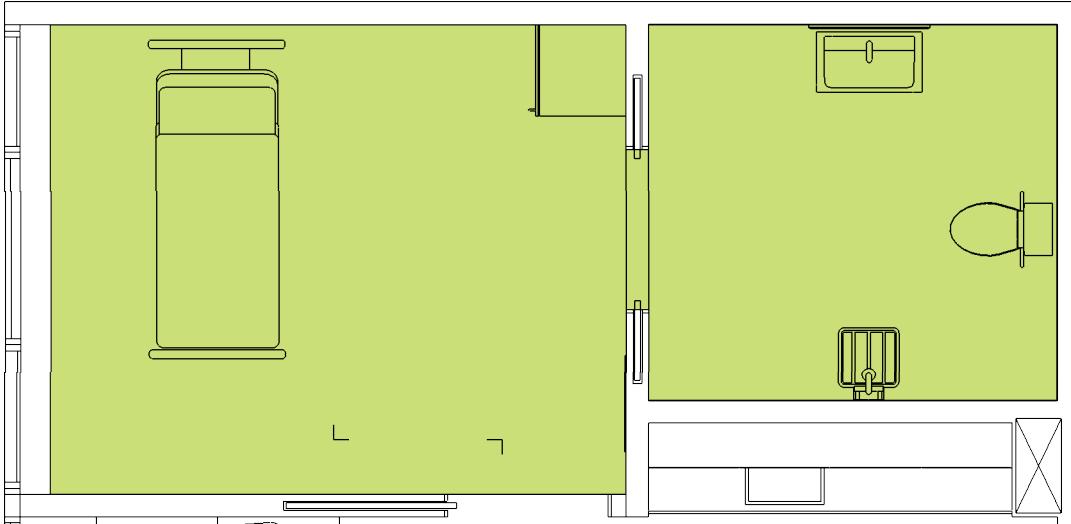

WALL MOUNTED

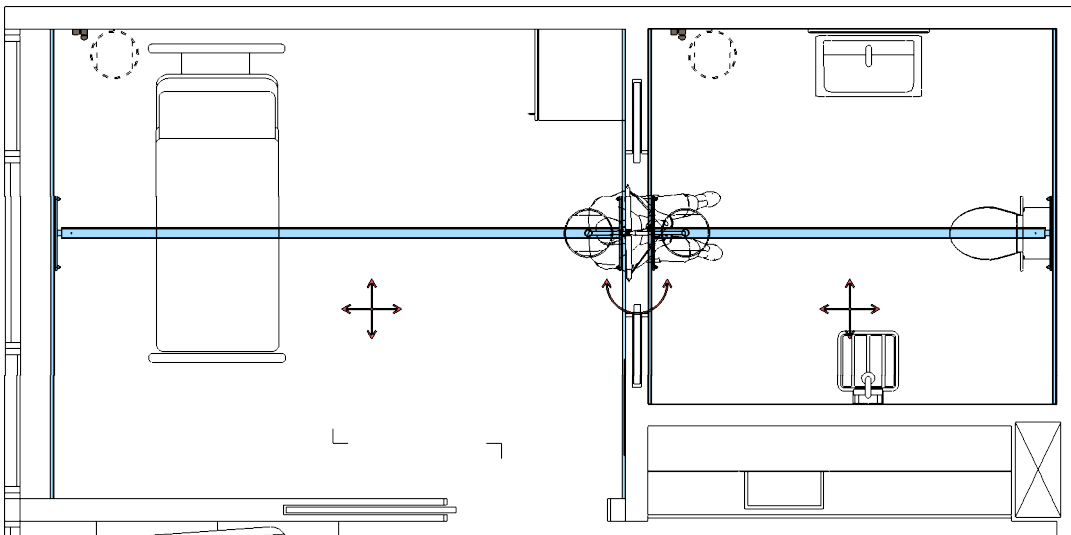

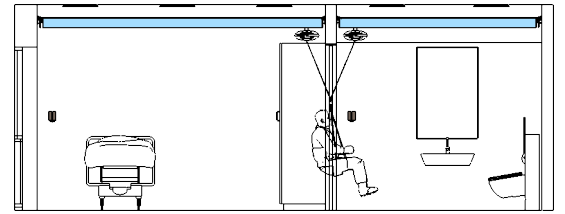

ROOM-TO-ROOM

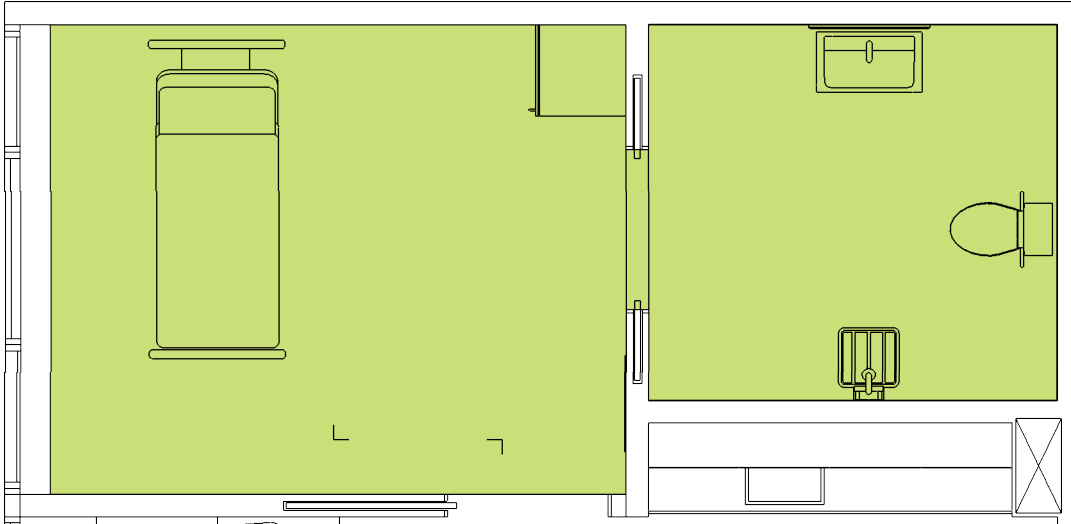

CEILING MOUNTED

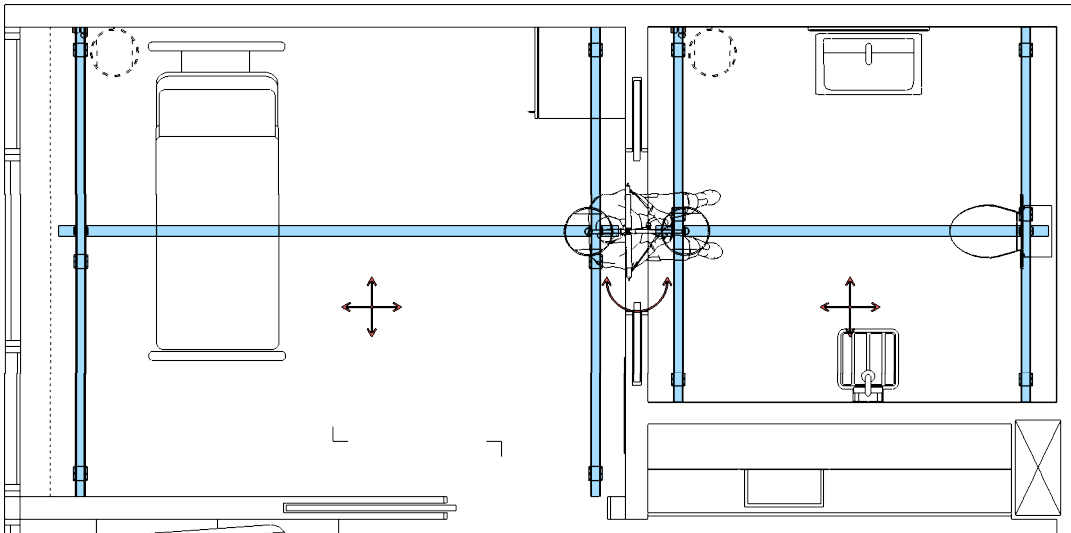

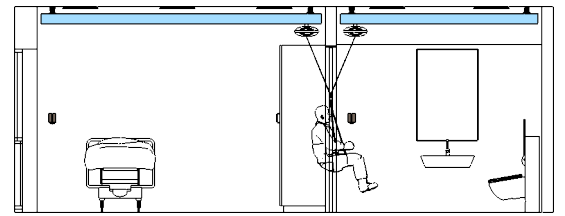

ROOM-TO-ROOM

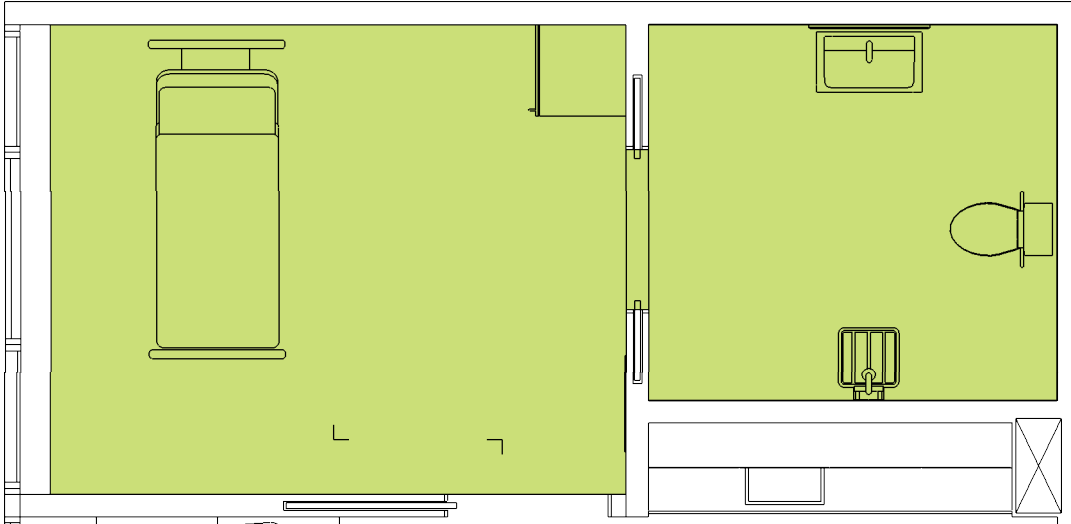

WALL MOUNTED

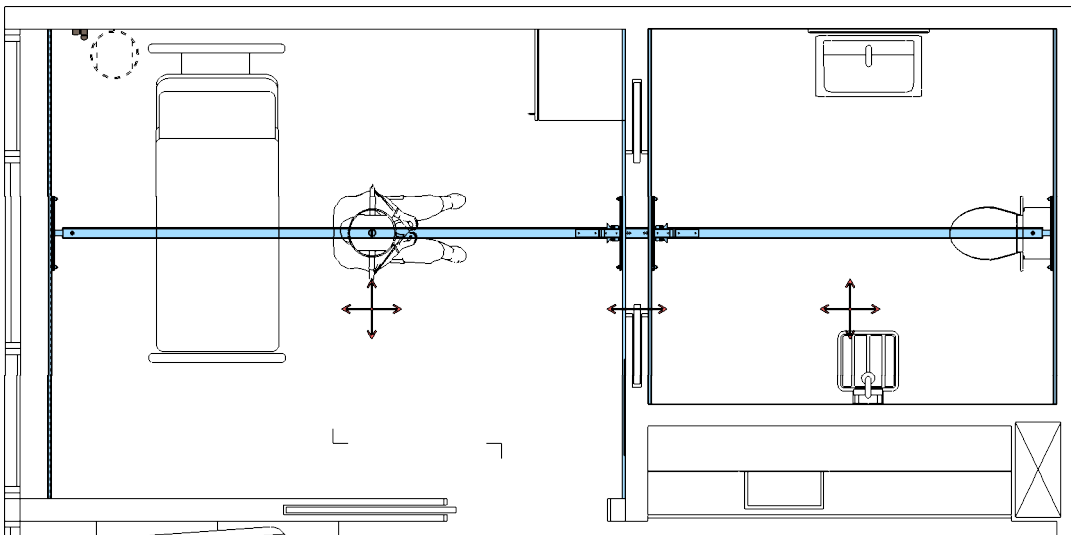

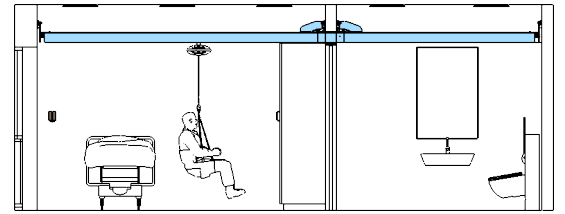

LIMITS

STANDARD

LIMITS
standard project
Ceiling lift
x room

type A
XY, wall mounted
weight class 200/275kg
roomheight - mm

all measurements and described
conditions needs to be controlled
on site. Solution based on ceiling
and walls dimensioned for mouting
track for ceiling lift.

drawing.no.:
EX.DBEX.LIM.A.01
drawing. date:
02.10.2014 Rev.: -
project reg.:
02.10.2014
scale:
1:50 @ A4

sales manager:
Ergolet Sales
info@ergolet.dk

project by:
Dan Betak, arkitekt MAA
dbe@ergolet.dk

contact information:
Ergolet
Taarnborgvej 12C
DK-4220 Korsoer
Denmark

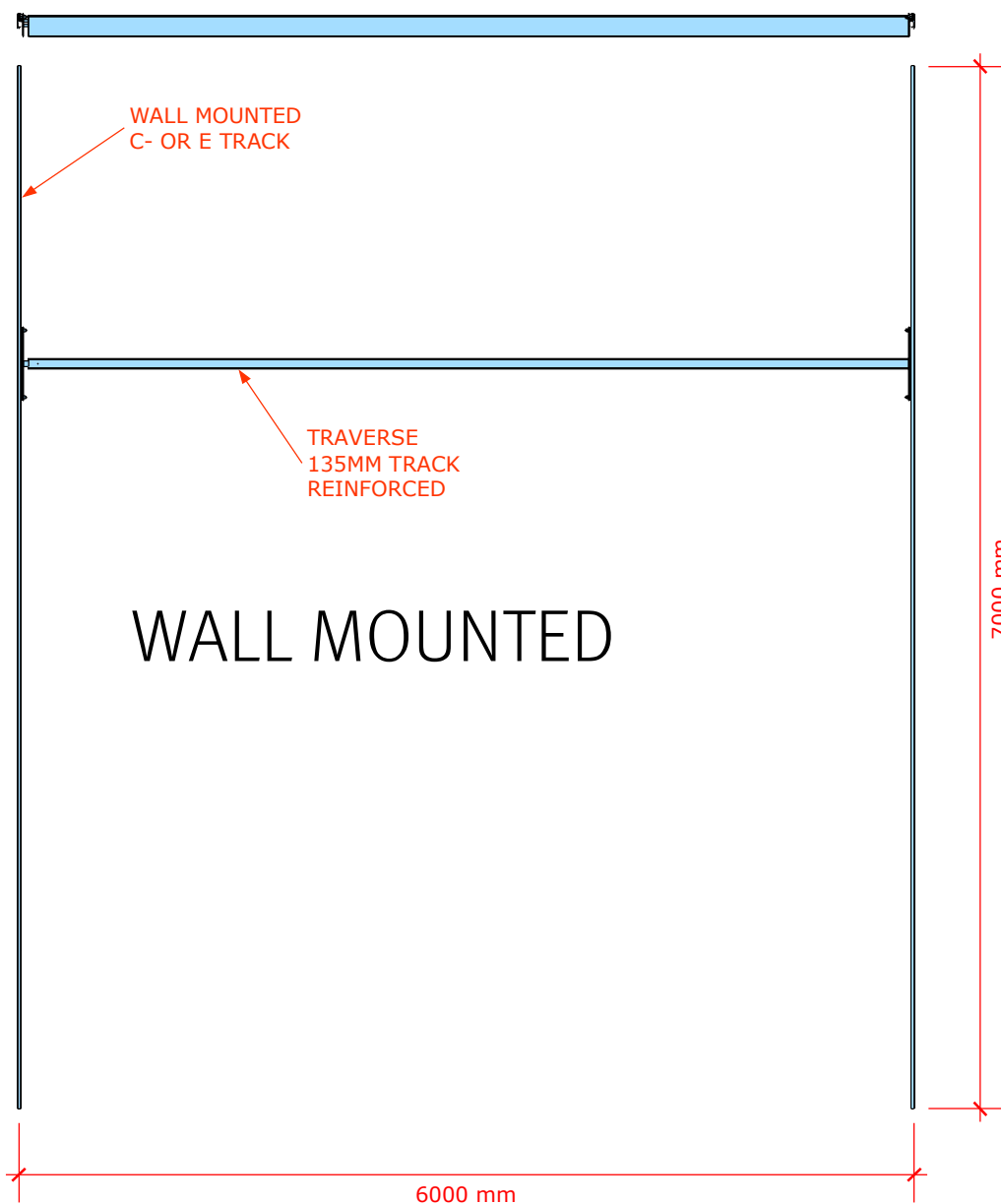

LIMITS

STANDARD

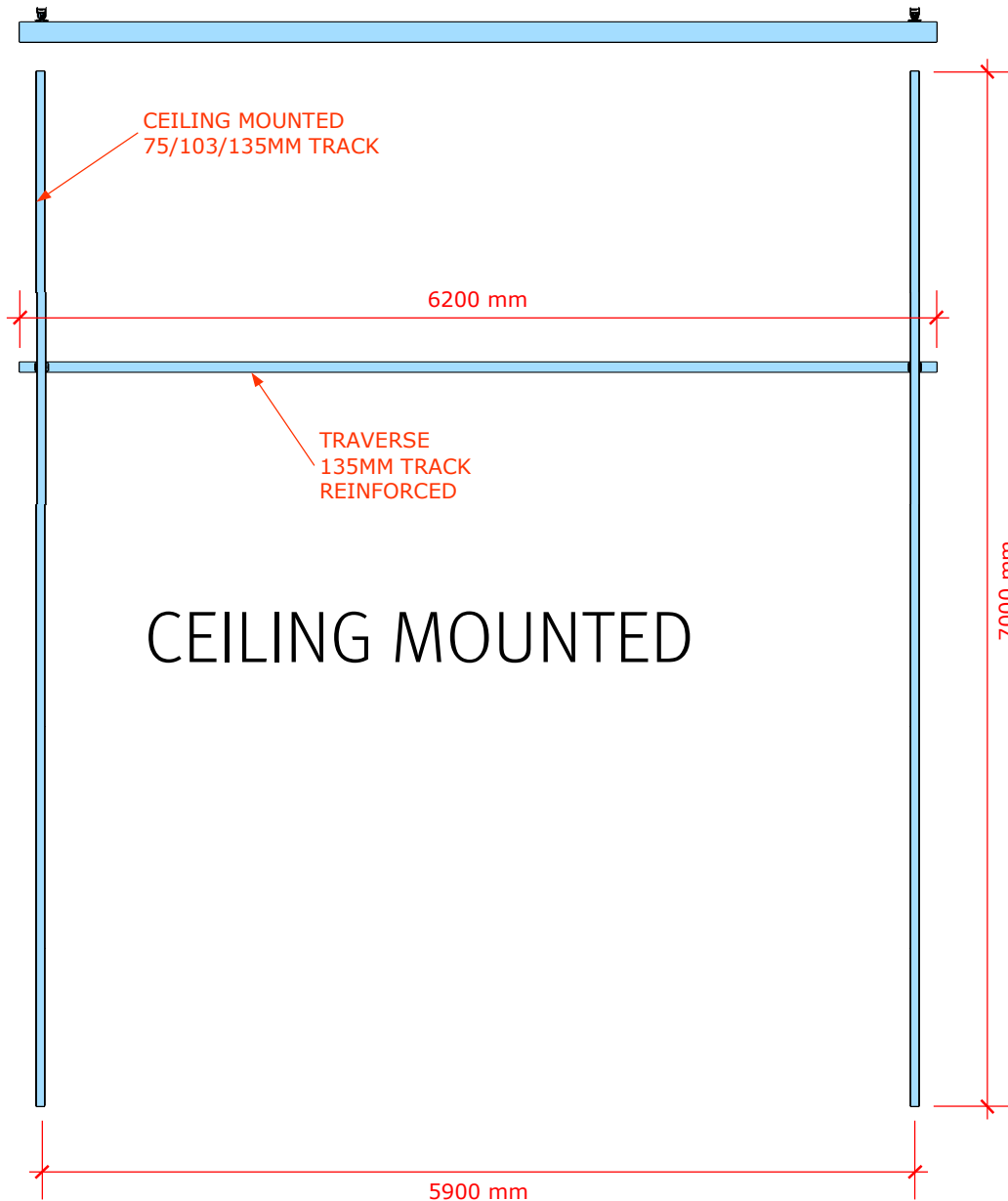

LIMITS

standard project

Ceiling lift

x room

type B

XY, ceiling mounted

weight class 200/275kg

roomheight - mm

all measurements and described conditions needs to be controlled on site. Solution based on ceiling and walls dimensioned for mounting track for ceiling lift.

drawing.no.:

EX.DBEX.LIM.B.01

drawing. date:

02.10.2014

Rev.: -

project reg.:

02.10.2014

scale:

1:50 @ A4

sales manager:

Ergolet Sales

info@ergolet.dk

project by:

Dan Betak, arkitekt MAA

dbe@ergolet.dk

contact information:

Ergolet

Taarnborgvej 12C

DK-4220 Korsøer

Denmark



www.ergolet.com

This drawing is the property of Ergolet and may not be copied or handed over to a third party without Ergolet written consent

LIMITS

STANDARD

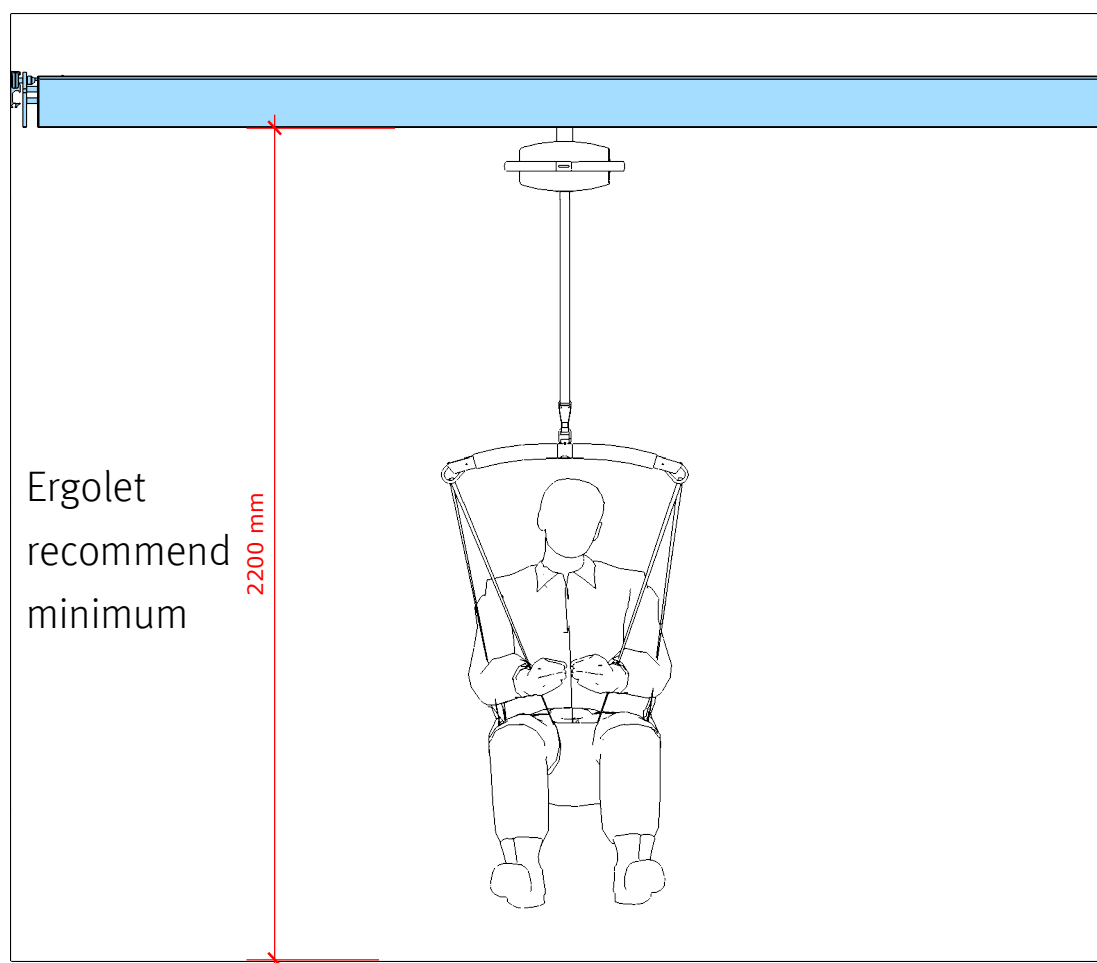

LIMITS

standard project

Ceiling lift

x room

XY, ceiling-/wall mounted
weight class 200/275kg
roomheight - mm

all measurements and described
conditions needs to be controlled
on site. Solution based on ceiling
and walls dimensioned for mouting
track for ceiling lift.

drawing.no.:

EX.DBEX.LIM.C.01

drawing. date:

02.10.2014

Rev.: -

project reg.:

02.10.2014

scale:

1:50 @ A4

sales manager:

Ergolet Sales

info@ergolet.dk

project by:

Dan Betak, arkitekt MAA

dbe@ergolet.dk

contact information:

Ergolet

Taarnborgvej 12C

DK-4220 Korsoer

Denmark



LIMITS

STANDARD

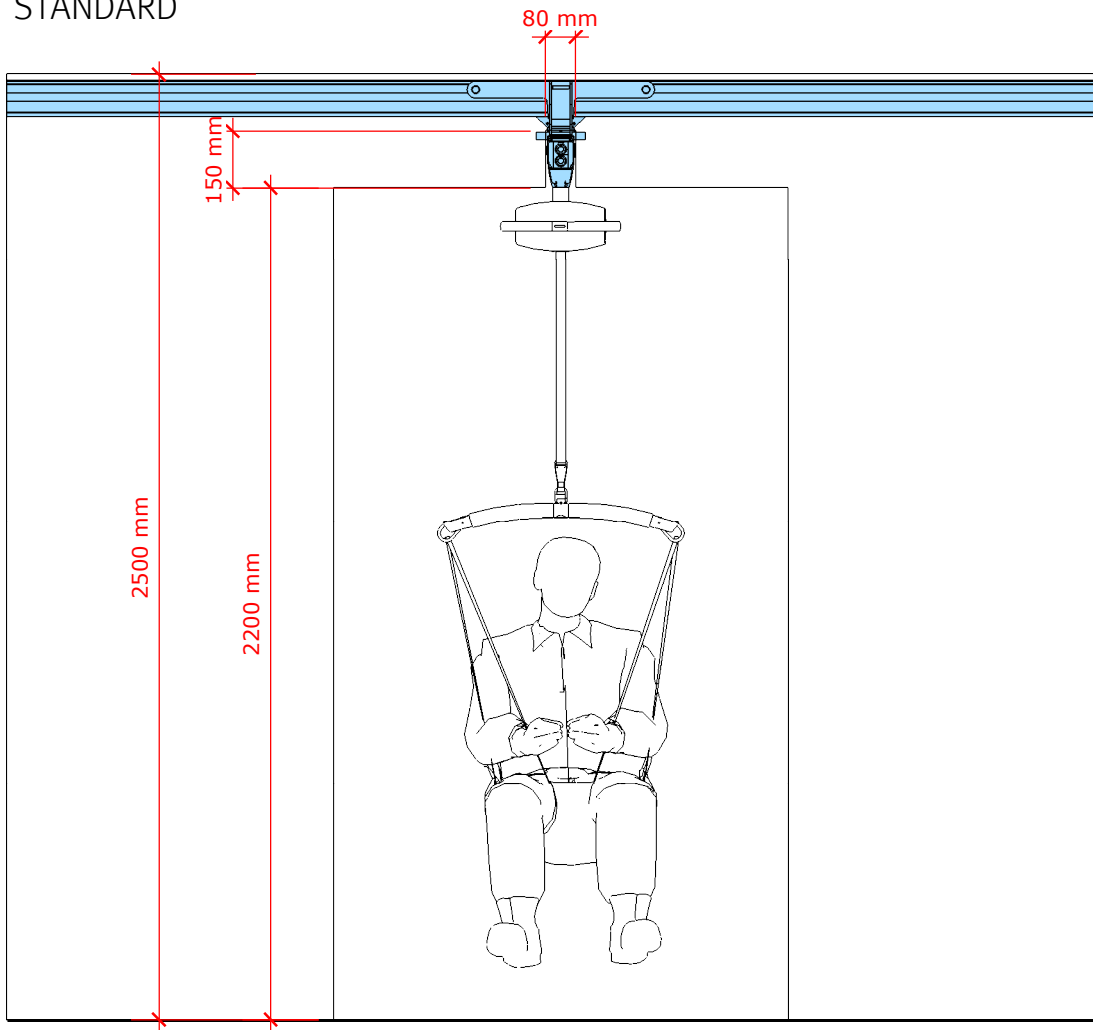

LIMITS

standard project

Ceiling lift

x room

XY, wall mounted
weight class 200/275kg
roomheight min. 2500 mm

all measurements and described conditions needs to be controlled on site. Solution based on ceiling and walls dimensioned for mounting track for ceiling lift.

drawing.no.:
EX.DBEX.LIM.D.01

drawing. date:
02.10.2014 Rev.: -

project reg.:
02.10.2014

scale:
1:50 @ A4

sales manager:
Ergolet Sales
info@ergolet.dk

project by:
Dan Betak, arkitekt MAA
dbe@ergolet.dk

contact information:
Ergolet
Taarnborgvej 12C
DK-4220 Korsoer
Denmark





www.ergolet.com

This drawing is the property of Ergolet and may not be copied or handed over to a third party without Ergolet written consent

OPTIONS

CHARGER STATION

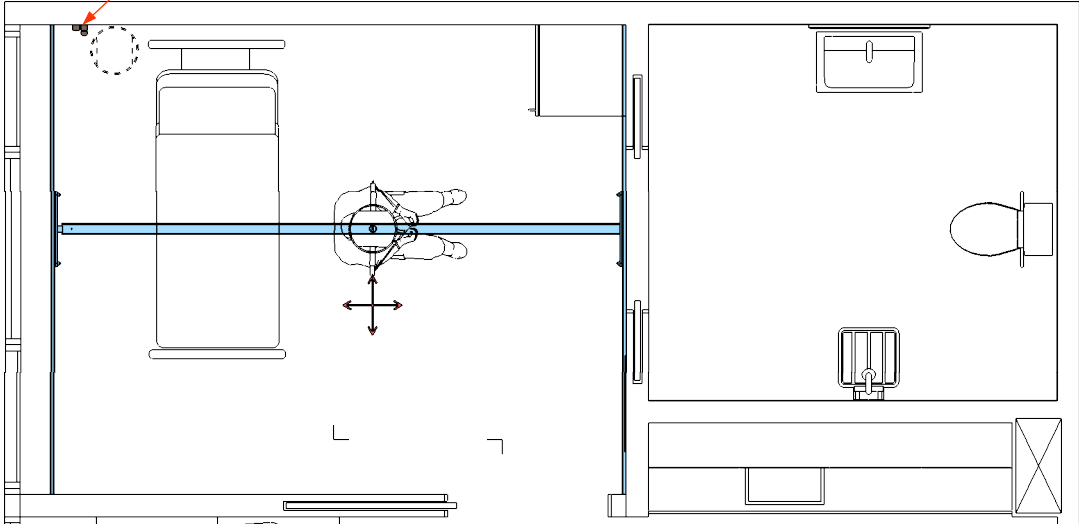
example
position of
charger station



example
position of
charger station

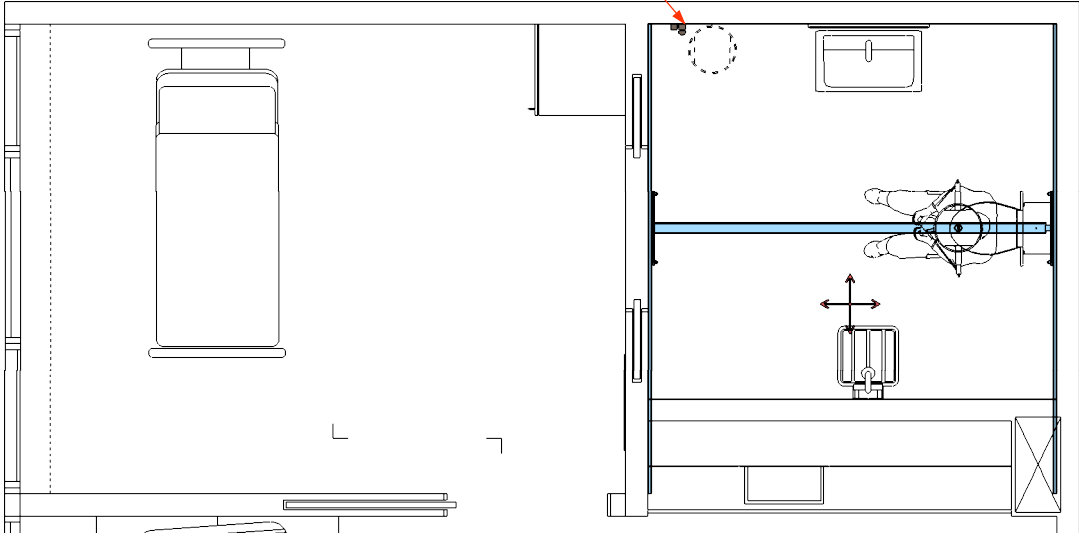

LIMITS

STANDARD



ARCHITECT SERVICE

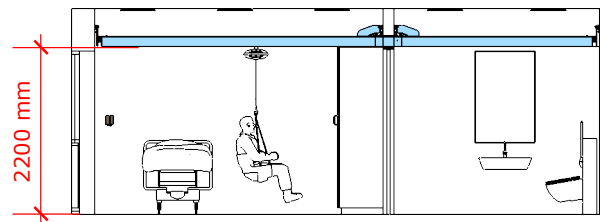

NOTE
doorconnector
integrated with sliding door

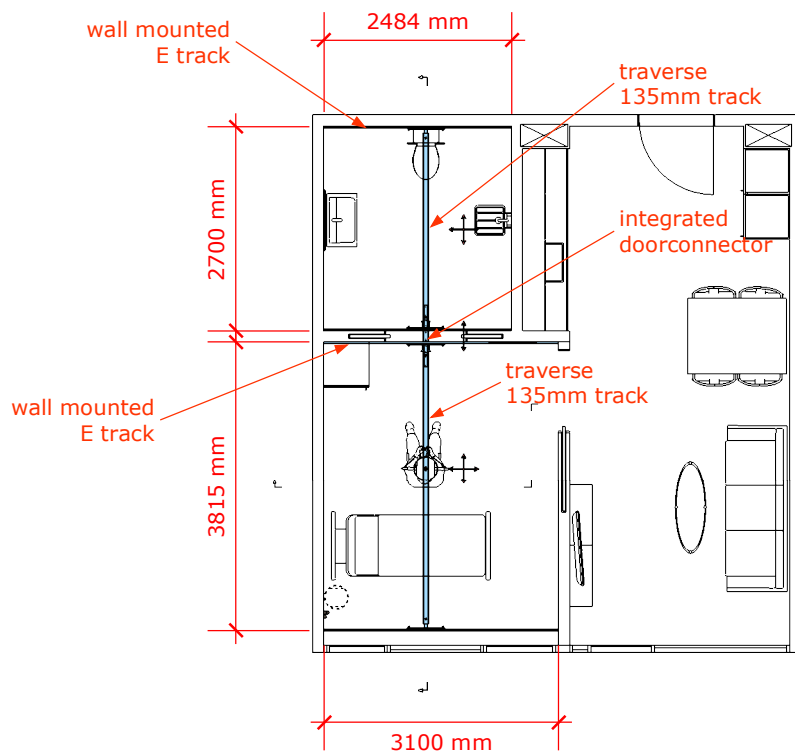
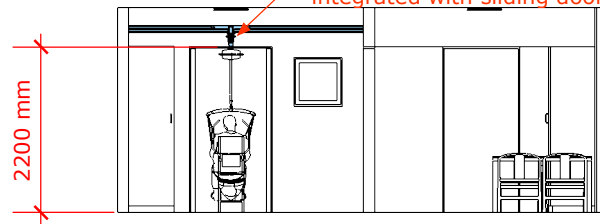

PROJECT
service
Ceiling lift
40 room

type A, 24
XY, wall mounted
weight class 200kg
roomheight min. 2500 mm

all measurements and described
conditions needs to be controlled
on site. Solution based on ceiling
and walls dimensioned for routing
track for ceiling lift.

drawing.no.:
EX.DBEX.LIM.E.01

drawing. date:
02.10.2014 Rev.: -

project reg.:
02.10.2014

scale:
1:100 @ A4

sales manager:
Ergolet Sales
info@ergolet.dk

project by:
Dan Betak, arkitekt MAA
dbe@ergolet.dk

contact information:
Ergolet
Taarnborgvej 12C
DK-4220 Korsoer
Denmark

A: PLAN, SECTION AND ELEVATION

Scan



See the Architect File
on the web



Questions?

'Seen from an architectural point of view'

please contact:

Dan Betak

Architect MAA, cand.arch.

dbe@ergolet.dk

ARCHITECT

EXTRA



B: PERSPECTIVE



C: ANIMATION



ARCHITECT FILE

HOW TO...

lift a person from A to B

seen from an architectural point of view

Ergolet
Taarnborgvej 12C
DK-4220 Korsoer
Denmark

+45 70 27 37 20
info@ergolet.dk
ww.ergolet.dk

www.ergolet.com

This drawing is the property of Ergolet and may not be copied or handed over to a third party without Ergolet written consent